

Basic Non Fail-Safe actuator for controlling dampers in typical commercial HVAC applications.

- Actuating force motor 450 N [100 lbf]
- Nominal voltage AC/DC 24 V
- Control On/Off, Floating point



5-year warranty



Technical data

Electrical data	Nominal voltage	AC/DC 24 V
	Nominal voltage frequency	50/60 Hz
	Nominal voltage range	AC 19.2...28.8 V / DC 19.2...28.8 V
	Power consumption in operation	2 W
	Power consumption in rest position	0.5 W
	Transformer sizing	4.5 VA
	Electrical Connection	18 GA plenum cable, 1 m, with 1/2" conduit connector
	Overload Protection	electronic throughout full stroke
Functional data	Actuating force motor	450 N [100 lbf]
	Direction of motion motor	reversible with switch
	Manual override	external push button
	Stroke	4" [100 mm]
	Running Time (Motor)	150 s / 100 mm
	Noise level, motor	35 dB(A)
Safety data	Power source UL	Class 2 Supply
	Degree of protection IEC/EN	IP54
	Degree of protection NEMA/UL	NEMA 2
	Enclosure	UL Enclosure Type 2
	Agency Listing	cULus acc. to UL60730-1A/-2-14, CAN/CSA E60730-1:02 CE acc. to 2014/30/EU and 2014/35/EU
	Quality Standard	ISO 9001
	UL 2043 Compliant	Suitable for use in air plenums per Section 300.22(C) of the NEC and Section 602 of the IMC
	Ambient humidity	Max. 95% RH, non-condensing
	Ambient temperature	-22...122°F [-30...50°C]
	Storage temperature	-40...176°F [-40...80°C]
Servicing	maintenance-free	
Weight	Weight	2.9 lb [1.2 kg]
Materials	Housing material	UL94-5VA
Footnotes	†Rated Impulse Voltage 800V, Type of Action 1, Control Pollution Degree 2.	

Product features

Application For on/off and floating point control of dampers in HVAC systems. Actuator sizing should be done in accordance with the damper manufacturer's specifications.

Operation The actuator is not provided with and does not require any limit switches, but is electronically protected against overload. The anti-rotation strap supplied with the actuator will prevent lateral movement. The actuator provides 4" [100 mm] of linear stroke. The stroke of the gear rack can be adjusted on both sides in increments of 0.8 in [20 mm] by means of the mechanical end stops. When reaching the damper or actuator end position, the actuator automatically stops. The gears can be manually disengaged with a button on the actuator cover. The actuators use a sensorless brushless DC motor, which is controlled by an Application Specific Integrated Circuit (ASIC). The ASIC monitors and controls the actuator's rotation and provides a digital rotation sensing (DRS) function to prevent damage to the actuator in a stall condition. Power consumption is reduced in holding mode.

Typical specification Floating point, on/off control damper actuators shall be electronic type, with integrated linear stroking arm. Actuators shall have brushless DC motor technology and be protected from overload at all positions of linear stroke. Actuators shall have reversing switch and manual override on the cover. Run time shall be constant and independent of torque. Actuators shall be cUL listed, have a 5-year warranty, and be manufactured under ISO 9001 International Quality Control Standards. Actuators shall be as manufactured by Belimo.

Accessories

Electrical accessories	Description	Type
	Signal simulator, Power supply AC 120 V	PS-100
	Battery backup system, for non-spring return models	NSV24 US
	Battery, 12 V, 1.2 Ah (two required)	NSV-BAT
	Transformer, AC 120 V to AC 24 V, 40 VA	ZG-X40
	Cable conduit connector 1/2"	TF-CC US
Mechanical accessories	Description	Type
	Ball joint suitable for damper crank arm KH8 / KH10, Multipack 10 pcs.	KG10A
	Ball joint suitable for damper crank arm KH8, Multipack 10 pcs.	KG6
	Ball joint suitable for damper crank arm KH8, Multipack 10 pcs.	KG8
	Push rod for KG6 & KG8 ball joints (36" L, 5/16" diameter).	SH8
	Rotary support, for linear actuator, for compensation of transverse forces	Z-DS1
	3/8"-16 shaft clevis for AHK/AH.	Z-KSC
	Bracket for AHK/AH/LH linear actuators.	ZG-119

Electrical installation

- Ⓐ Actuators with appliance cables are numbered.
- ⚠️ Provide overload protection and disconnect as required.
- ⚠️ Actuators may also be powered by DC 24 V.
- ⚠️ Actuators Hot wire must be connected to the control board common. Only connect common to neg. (-) leg of control circuits. Terminal models (-T) have no-feedback.
- ⚠️ Actuators may be connected in parallel if not mechanically linked. Power consumption and input impedance must be observed.

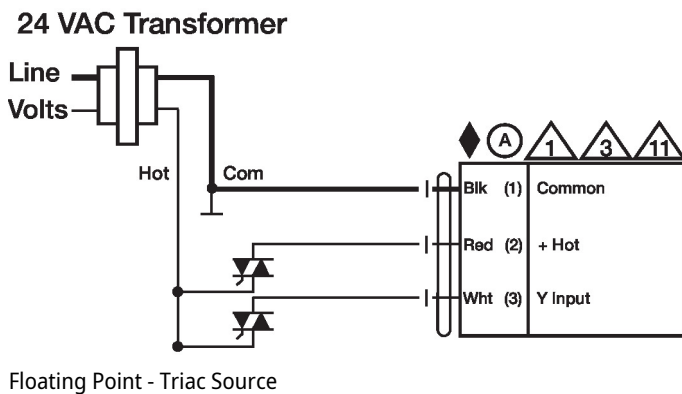

Wiring diagrams

On/Off

24 VAC Transformer

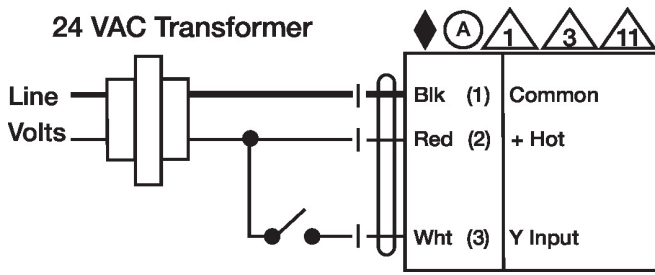

Floating Point

24 VAC Transformer

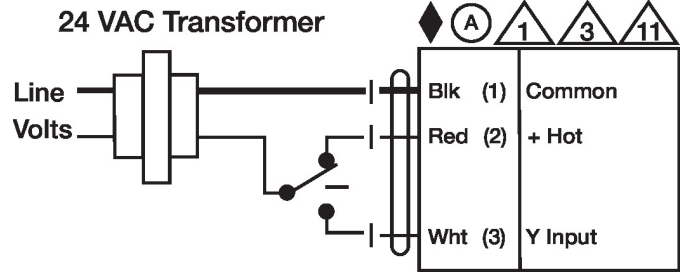

Floating Point - Triac Source

24 VAC Transformer

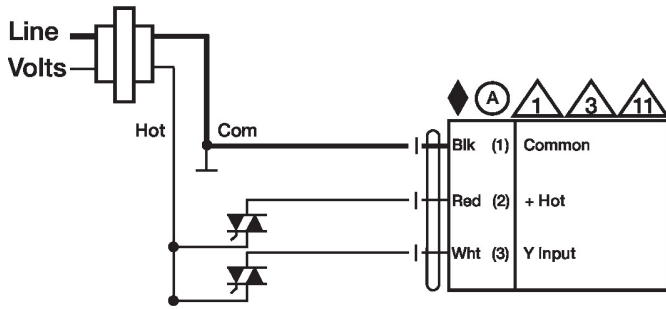

Floating Point - Triac Sink

24 VAC Transformer

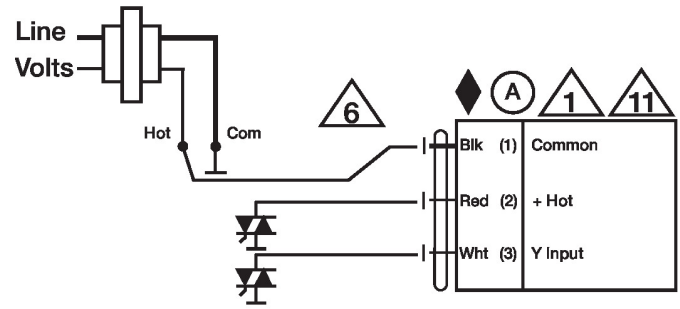

Dimensions

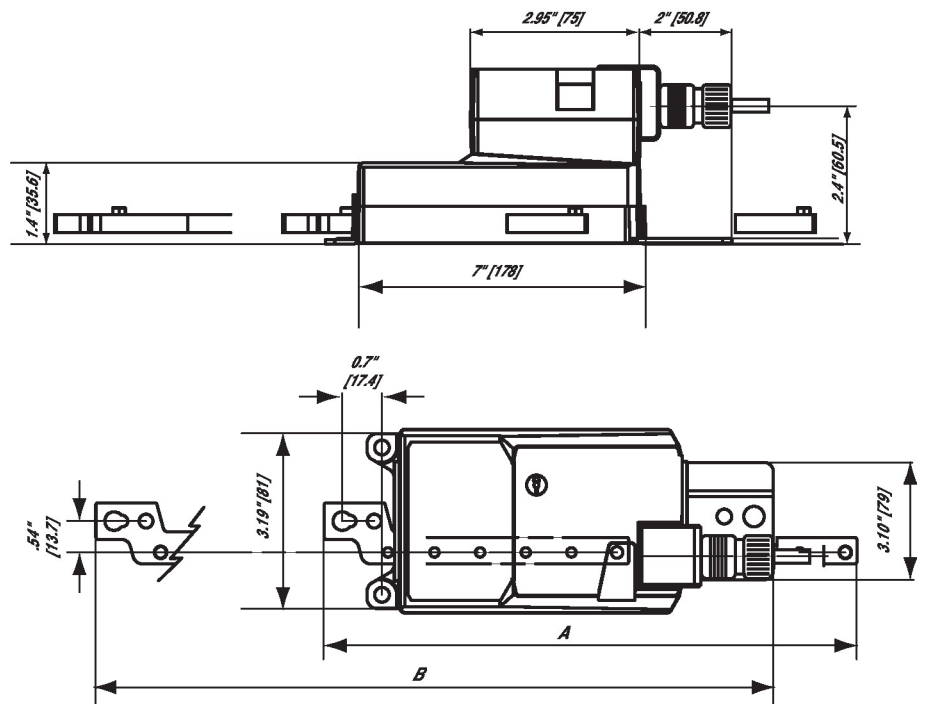

Stroke	A	B
4" [100]	9.2" [233.5]	8" [203.2]