

UFLKP005 PR/PKR Retrofit Butterfly Valve Linkage

For Use with PR and PKR Series Actuators

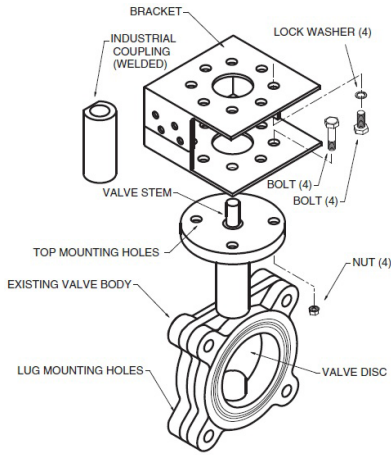

Technical Data	
Hardware	zinc plated steel
Frame, plate, base	stainless steel
Shaft	stainless steel
Coupling	Stainless Steel
Mounting Position	360°
Weight	7.0 lb [3.2 kg]

For close-off pressure reference Select Pro or Retrofit Technical Documentation.

Application

The UFLK/UBLK retrofit kit is designed to easily attach to the valve mounting pad on select competitor butterfly valves utilizing Belimo actuators. This kit will help to restore service without removal of the valve, saving down time. The retrofit kit is available in various configurations for use with both 2-way and 3-way valves utilizing single or dual actuation where applicable.

Operation

The UFLK and mounted actuator(s) are capable of rotating 90° in both CW and CCW directions. This allows the disc to fully open or close. When directional needs vary, the actuator's directional switch can be flipped to change the rotation. The SY/PR is NEMA 4X rated and can be used outdoors.

Default/Configuration

The actuator is sold separately from the linkage. This allows users to select any actuator with the desired control signal. Since the linkage utilizes standard airside actuators, they can be purchased at any time and mounted in the field.

Suitable Actuators

	Non-Spring	US only
UFLKP005	PRB(X)	PKRB(X)

Dimensions (Inches [mm])

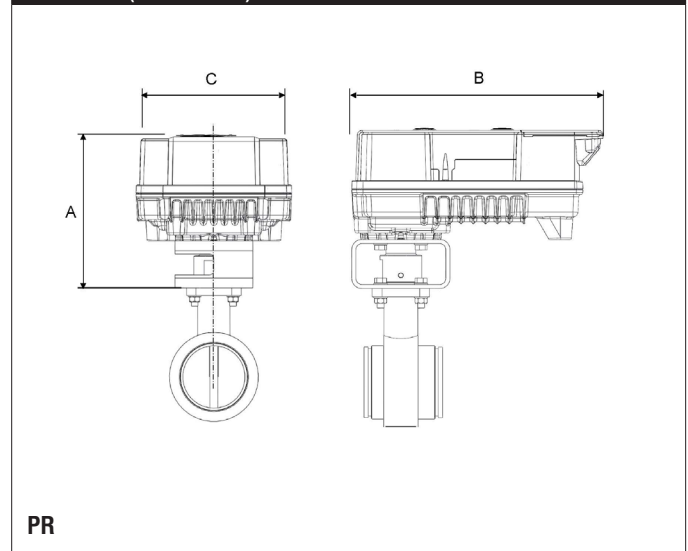

A	B	C
9.7" [247]	12.00" [305]	7.87" [200]

Date created, 09/26/2018 - Subject to change. © Belimo Aircontrols (USA), Inc.