

RM7890A/B 7800 SERIES Relay Modules

INSTALLATION INSTRUCTIONS

APPLICATION

The Honeywell RM7890A/B Relay Modules are microprocessor based integrated burner controls for automatically fired, gas only (if Valve Proving feature is going to be used), single burner on/off applications. The RM7890A/B System consists of a relay module, subbase, and amplifier. Options include keyboard display module (KDM) and remote display mounting.

Functions the RM7890 provides include automatic on/off burner sequencing, flame supervision, system status indication, system or self-diagnostics and troubleshooting.

This document covers the following 7800 Series Relay Modules:

- RM7890A1056
- RM7890B1048
- RM7890A2056
- RM7890B2048

RM7890A/B Relay Modules offer the following additional features:

- Preignition Interlock Input
- Selectable Intermittent/Interrupted Pilot Function (full pilot flame and main flame establishing periods apply if interrupted pilot feature selected).
- Run/Test Switch for interrupted pilot setup.
- Blinkum fault annunciation on safety shutdown (power LED blinks a fault code).
- Built-in features set up only using the S7800A1142 display.
- Valve Proving System.

The Valve Proving System feature provides a systematic way of testing the valve seat integrity to assure the valves are indeed in the closed state when the system is in Standby.

Content

APPLICATION	1
SPECIFICATIONS	2
INSTALLATION	2
STATIC CHECKOUT.....	6
VALVE PROVING SYSTEM.....	10
PRINCIPAL TECHNICAL FEATURES	14
OPERATION	14
SETTINGS AND ADJUSTMENTS ...	15

At commissioning time, the Valve Proving System may be scheduled to occur at one of five different times:

1. Never—Device default as received; valve proving does not occur.
2. Before—Valve proving after standby and safe start check, prior to ignition trials.
3. After—Valve proving occurs after the Run state before the device goes to Standby.
4. Both—Valve proving occurs at both times Before and After noted above.
5. Split—The downstream (high pressure) seat test is performed at the Before time and the upstream (low pressure) seat test is performed during the After time.

The following assumptions apply when using the RM7890A/B Valve Proving testing:

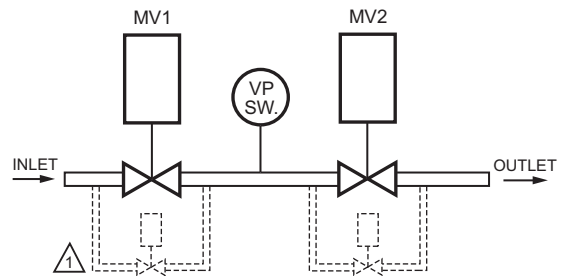

CAUTION: VALVE ENERGIZING TIMING IS BASED ON VALVE OPENING TIMES OF 13 SECONDS MAXIMUM.
 - FOR VALVES WITH TIMINGS GREATER THAN 13 SECONDS - A BYPASS SOLENOID (RATED AS A SAFETY SHUTOFF VALVE) VALVE (1/4", 120 VAC) IS REQUIRED TO OBTAIN THE PROPER TEST PRESSURES.
 - THE BYPASS VALVE WILL BE WIRED IN PARALLEL TO THE VALVE IT IS BYPASSING (TERMINAL 9 FOR MV1 OR TERMINAL 17 FOR MV2).

M22660B

Fig. 1. Valve Proving System—simplified diagram.

SYSTEM CHECKOUT.....	16
INITIAL LIGHTOFF CHECKS.....	17
PILOT TURNDOWN TEST (ALL INSTALLATIONS USING A PILOT).....	18
IGNITION INTERFERENCE TEST (ALL FLAME RODS).....	19
HOT REFRACTORY TESTS.....	19
IGNITION SPARK RESPONSE TEST (ALL ULTRAVIOLET DETECTORS).....	19
SAFETY SHUTDOWN TESTS (ALL INSTALLATIONS).....	20
TROUBLESHOOTING.....	21
SAFETY AND SECURITY.....	27



MV1—Wired to terminal 9. It is located at the most upstream position of the main gas valve train.
 VPS—Valve Proving Switch (Rated 1/2 of main valve inlet pressure).
 MV2—Wired to terminal 17. It is the main valve located closest to the burner.
 The Proof of Closure Switch (or PII—Preignition Interlock) for terminal 20 can be installed on MV1, MV2, or both valves.
Explosion Hazard.
 Can cause severe injury, death or property damage.
 Be sure to select adequate testing times when the Valve Proving feature is enabled. A shorter time can result in inadequate leak testing of the valves.
 This document provides installation and static checkout instructions. Other applicable publications are:

Form Number	Description
32-0110	S7800A2142 4-line LCD Keyboard Display Module Product Data
32-0166	204729A/C KDM NEMA4 Covers for 4-line LCD KDM
65-0084	Q7800A,B 22-Terminal Wiring Subbase Product Data
65-0091	S7810A Data ControlBus Module™ Product Data
65-0095	S7820 Remote Reset Module Product Data
65-0097	221729C Dust Cover Packing Sheet
65-0109	R7824, R7847, R7848, R7849, R7851, R7861, R7886 Flame Amplifiers for the 7800 SERIES Product Data
65-0131	221818A Extension Cable Assembly Product Data
65-0288	S7800A1142 Keyboard Display Module Product Data
65-0229	7800 SERIES Relay Modules Checkout and Troubleshooting
65-0249	S7810M ModBus Module
65-0295	50023821-001/2 NEMA4 Covers for 2-line Keyboard Display Module

SPECIFICATIONS

Electrical Ratings (See Table 3):

Voltage and Frequency:
 RM7890: 120 Vac (+10/-15%), 50/60 Hz (±10%).
 Power Dissipation: 10W maximum.
 Maximum Total Connected Load: 2000 VA.
 Fusing Total Connected Load: 15A maximum, type SC or equivalent, fast blow.

Environmental Ratings:

Ambient Temperature:
 Operating: -40°F to +140°F (-40°C to +60°C).
 Storage: -40°F to +150°F (-40°C to +66°C).
 Humidity: 85% relative humidity continuous, noncondensing.
 Vibration: 0.5G environment.

SIL 3 Capable:

SIL 3 Capable in a properly designed Safety Instrumented System. See form number 65-0312 for Certificate Agreement.

Approvals:

RM7890A,B:
 Underwriters Laboratories Inc. Listed: File No. MP268, Guide No. MCCZ.
 Factory Mutual Approved: Report No. J.I.1V9A0.AF.
 Swiss RE (Formerly IR) : Acceptable.
 Federal Communications Commission: Part 15, Class B, Emissions.
 EAC: TC N RU д-US.Aи3O.B.04013.

INSTALLATION

When Installing this Product...

1. Read these instructions carefully. Failure to follow them could damage the product or cause a hazardous condition.
2. Check the ratings given in the instructions and marked on the product to make sure the product is suitable for the application.
3. Installer must be a trained, experienced, flame safeguard service technician.
4. After installation is complete, check out the product operation as provided in these instructions.



WARNING

Fire or Explosion Hazard.

Can cause property damage, serious injury, or death.

To prevent possible hazardous burner operation, verify safety requirements each time a control is installed on a burner.



WARNING

Electrical Shock Hazard.

Can cause personal injury, death or equipment damage.

Disconnect the power supply before beginning installation.

IMPORTANT

1. Wiring connections for the relay modules are unique; refer to Fig. 3 or the appropriate Specifications for individual subbase wiring.
2. Wiring must comply with all applicable codes, ordinances and regulations.
3. Wiring must comply with NEC Class 1 (Line Voltage) wiring.
4. Loads connected to the RM7890 must not exceed those listed on the RM7890 label or the Specifications; see Tables 3, 4, and 5.
5. Limits and interlocks must be rated to simultaneously carry and break current to the ignition transformer, pilot valve, and main fuel valve(s).
6. All external timers must be listed or component-recognized by authorities who have proper jurisdiction.

7. For on-off gas-fired systems, some authorities who have jurisdiction prohibit the wiring of any limit or operating contacts in series between the flame safeguard control and the main fuel valve(s).
8. Two flame detectors can be connected in parallel with the exception of Infrared Flame Detectors (C7915) and solid state models C7927, C7952, and C7961.
9. This equipment generates, uses and can radiate radio frequency energy and, if not installed and used in accordance with the instructions, can cause interference with radio communications. It has been tested and found to comply with the limits for a Class B computing device of Part 15 of FCC rules which are designed to provide reasonable protection against such interference when operated in a commercial environment. Operation of this equipment in a residential area can cause interference, in which case, the users, at their own expense, may be required to take whatever measures are required to correct this interference.
10. This digital apparatus does not exceed the Class B limits for radio noise for digital apparatus set out in the Radio Interference Regulations of the Canadian Department of Communications.

Location

Humidity

Install the relay module where the relative humidity never reaches the saturation point. The relay module is designed to operate in a maximum 85% relative humidity continuous, noncondensing, moisture environment. Condensing moisture can cause a safety shutdown.

Vibration

Do not install the relay module where it can be subjected to vibration in excess of 0.5G continuous maximum vibration.

Weather

The relay module is not designed to be weather tight. When installed outdoors, protect the relay module in an approved weather-tight enclosure.

Mounting Wiring Subbase

See Fig. 3 for the internal block diagram of RM7890 Relay Module.

1. Mount the subbase in any position except horizontally with the bifurcated contacts pointing down. The standard vertical position is recommended. Any other position decreases the maximum ambient temperature rating.
2. Select a location on a wall, burner or electrical panel. The Q7800 can be mounted directly in the control cabinet. Be sure to allow adequate clearance for servicing, installation, access or removal of the RM7890, expanded annunciator, KDM, flame amplifier, flame amplifier signal voltage probes, run/test switch, electrical signal voltage probes and electrical field connections.

3. For surface mounting, use the back of the subbase as a template to mark the four screw locations. Drill the pilot holes.
4. Securely mount the subbase using four no. 6 screws (not provided).

Relay Module and Subbase Compatibility

NOTE: There are several different subbase models that can be purchased. It is important to note which subbase is compatible with the relay module when purchasing new, repair or replacement parts.

Series 1000 Relay Modules

All relay product codes that start with a 1 (example: RM7840G1014/U) can be used with existing subbase Q7800A1003/U and Q7800A1005/U.

Series 2000 Relay Modules

All relay product codes that start with a 2 (example: RM7840G2014/U) must be used with subbase Q7800A2003/U and Q7800A2005/U.

Subbase Compatibility

Any Relay Module in the 1000 Series with a Software Revision level number starting with a "5" or greater will be compatible with all subbase models both installed and newly purchased. This includes (Q7800A1005/U, Q7800B1003/U), and the 2000 Series subbases (Q7800A2005/U, Q7800B2003/U).

See Fig. 2 for Software Revision Level number location on the label (located on the rear of the relay module).

Any relay module in the new 2000 series will only be able to be installed on subbase Q7800A2005/U, Q7800B2003/U and will not be backward compatible with any Q7800A1003/U and Q7800A1005/U subbases already installed in the field.



Fig. 2. Software revision location.

IMPORTANT

Make sure to check the relay model number and the software revision level on the relay.

5. If you attempt to place a 2000 series relay on a non-compatible 1000 series subbase, you will receive an error code of 101. This indicates that you must a) change out the subbase to a Q7800A2003/U or Q7800A2005/U or b) choose a compatible 1000 series relay module.

Wiring

WARNING

Electrical Shock Hazard.

Can cause personal injury or equipment damage. Disconnect the power supply before beginning installation.

1. For proper subbase wiring and sequence chart, refer to Fig. 4.
2. For proper remote wiring of the KDM, refer to the Specifications for the 2-line VDF KDM (65-0090), the 4-line LCD KDM (32-00110) Data ControlBus Module™ (65-0091) or Extension Cable Assembly (65-0131).
3. Disconnect the power supply from the main disconnect before beginning installation to prevent electrical shock and equipment damage. More than one disconnect can be required.
4. All wiring must comply with all applicable electrical codes, ordinances and regulations. Wiring, where required, must comply with NEC, Class 1 (Line Voltage) wiring.
5. Use recommended wire routing of leadwires:
 - a. Do not run high voltage ignition transformer wires in the same conduit with the flame detector, Data ControlBus Module™, or Remote Reset Module wiring.
 - b. Do not route flame detector, Data ControlBus Module™, or Remote Reset Module leadwires in conduit with line voltage circuits.
 - c. Enclose flame detector leadwires without armor cable in metal cable or conduit.
 - d. Follow directions in flame detector, Data ControlBus Module™, or Remote Reset Module Instructions.

6. For KDM: Because the KDM is powered from a low voltage, energy limited source, it can be mounted outside of a control panel if it is protected from mechanical damage.

NOTE: Use 13 Vdc power supply any time more than two KDM or Data ControlBus Modules™ are used or are placed more than 100 feet (31 meters) from the relay module.

7. Maximum wire lengths:
 - a. RM7890 leadwires: The maximum leadwire length is 300 feet (91 meters) to terminal inputs (Control, Running/Lockout Interlock/Preignition Interlock).
 - b. Flame Detector leadwires: The maximum flame sensor leadwire length is limited by the flame signal strength.
 - c. Remote Reset leadwires: The maximum length of wire is 1000 feet (305 meters) to a Remote Reset pushbutton.
 - d. Data ControlBus Module™: The maximum Data ControlBus Module™ cable length depends on the number of system modules connected, the noise conditions and the cable used. The maximum length of all Data ControlBus Module™ interconnecting wire is 4000 feet (1219 meters).
8. For recommended wire size and type, see Table 1.
9. The KDM, Data ControlBus Module™ (for remote mounting) must be wired in a daisy chain configuration, 1(a)-1(a), 2(b)-2(b), 3(c)-3(c). The order of interconnection of all the devices listed above is not important. Be aware that modules on the closest and farthest end of the daisy chain configuration string may require a 120 ohm (1/4 watt minimum) resistor termination across terminals 1 and 2 of the electrical connectors for connections over 100 feet (31 meters).
10. For recommended grounding practices, see Table 2.
11. Be sure loads do not exceed the terminal ratings. Refer to the label on the RM7890 or to the terminal ratings in Table 3.

Table 1. Recommended Wire Sizes and Part Numbers.

Application	Recommended Wire Size	Recommended Part Numbers
Line voltage terminals	14, 16, or 18 AWG copper conductor, 600 volt insulation wire.	TTW60C, THW75C, THHN90C.
Keyboard Display Module	22 AWG two-wire twisted pair with ground, or five-wire.	Belden 8723 shielded cable or equivalent.
Data ControlBus Module™	22 AWG two-wire twisted pair with ground, or five-wire.	Belden 8723 shielded cable or equivalent.
Remote Reset Module	22 AWG two-wire twisted pair, insulated for low voltage.	—
13 Vdc full-wave rectified transformer power input.	18 AWG wire insulated for voltages and temperatures for given application.	TTW60C, THW75C, THHN90C.

Table 2. Recommended Grounding Practices.

Ground Type	Recommended Practice
Earth ground (subbase and relay module).	<ol style="list-style-type: none"> 1. Use to provide a connection between the subbase and the control panel of the equipment. Earth ground must be capable of conducting enough current to blow the 15A fuse (or breaker) in the event of an internal short circuit. 2. Use wide straps or brackets to provide minimum length, maximum surface area ground conductors. If a leadwire is required, use 14 AWG copper wire. 3. Make sure that mechanically tightened joints along the ground path are free of nonconductive coatings and protected against corrosion on mating surfaces.
Signal ground (Keyboard Display Module, Data ControlBus Module™).	Use the shield of the signal wire to ground the device to the signal ground terminals—3(c)—of each device. Connect the shield at both ends of the daisy chain to earth ground.

Table 3. Terminal Ratings.

Terminal Number	Description	Ratings (RM7890A,B)
G	Flame Sensor Ground	—
Earth G	Earth Ground ^a	—
L2(N)	Line Voltage Common	—
3	Line Voltage Supply (L1)	120 Vac (+10%/-15%), 50 or 60 Hz (±10%). ^b
4	Alarm	120 Vac, 1A pilot duty.
5	Unused	—
6	Burner Controller and Limits	120 Vac, 1 mA.
7	Jumper	120 Vac, 8A run, 43A inrush.
8	Pilot Valve/Ignition.	120 Vac. ^c
9	Main Fuel Valve 1.	120 Vac. ^c
10	Ignition	120 Vac, 4.5A ignition. ^c
F(11)	Flame Sensor	60 to 220 Vac, current limited.
12 to 15	Unused.	—
16	Valve Proving Switch	120V, 1 mA.
17	MV2 (for Valve Proving)	120 Vac. ^c
18	Unused	—
19	Unused	—
20	Preignition Interlock	120V, 1 mA
21	Unused	—
22	Shutter	120 Vac, 0.5A (RM7890B).

^a The RM7890 must have an earth ground providing a connection between the subbase and the control panel or the equipment. The earth ground wire must be capable of conducting the current to blow the 15A, type SC, fast blow, fuse (or breaker) in event of an internal short circuit. The RM7890 needs a low impedance ground connection to the equipment frame which, in turn, needs a low impedance connection to earth ground. For a ground path to be low impedance at RF frequencies, the connection must be made with minimum length conductors having maximum surface areas. Wide straps or brackets rather than leadwires are preferred. Be careful to verify that mechanically tightened joints along the ground path, such as pipe or conduit threads or surfaces held together with fasteners, are free of nonconductive coatings and are protected against mating surface corrosion.

^b 2000 VA maximum connected load to the RM7890 Assembly.

^c See Tables 4 and 5 for device load combinations.

Table 4. Combinations for Terminals 8, 9,17 and 10.

Pilot Fuel 8	Main 9 (MV1)	Main 17 (MV2)	Ignition 10
C	F	F	No Load
B	F	F	No Load
F	F	F	A
F	No Load	No Load	A
D	F	F	A
D	D	D	A
D	No Load	No Load	A

Table 5. Composition of Each Combination.

A	B	C	D	F
4.5A ignition	50 VA Pilot Duty plus 4.5A ignition.	180 VA ignition plus motor valves with: 660 VA inrush, 360 VA open, 250 VA hold.	2A Pilot Duty.	65 VA Pilot Duty plus motor valves with: 3850 VA inrush, 700 VA Open, 250 VA hold.

Final Wiring Check

1. Check the power supply circuit. The voltage and frequency tolerance must match those of the RM7890. A separate power supply circuit can be required for the RM7890. Add the required disconnect means and overload protection.
2. Check all wiring circuits and complete the Static Checkout in Table 7 before installing the RM7890 on the subbase.
3. Install the relay module.
4. Restore the panel power.

STATIC CHECKOUT

After checking all wiring, perform this checkout before installing the RM7890 on the subbase. These tests verify the Q7800 Wiring Subbase is wired correctly, and the external controllers, limits, interlocks, actuators, valves, transformers, motors and other devices are operating properly.

WARNING

Explosion Hazard.
Can cause serious injury, death or equipment damage.

1. Close all manual fuel shutoff valve(s) before starting these tests.
2. Use extreme care while testing the system. Line voltage is present on most terminal connections when power is on.
3. Open the master switch before installing or removing a jumper on the subbase.
4. Before continuing to the next test, be sure to remove test jumper(s) used in the previous test.
5. Replace all limits and interlocks that are not operating properly. Do not bypass limits and interlocks.



CAUTION

Equipment Damage Hazard.
Can cause equipment damage or equipment failure.

Do not perform a dielectric test with the RM7890 installed. Internal surge protectors break down and conduct a current, causing the RM7890 to fail the dielectric test or possibly destroy the internal lightning and high current protection.

Equipment Recommended

1. Voltmeter (1M ohm/volt minimum sensitivity) set on the 0 to 300 Vac scale.
2. Two jumper wires, No. 14 wire, insulated, 12 in. (304.8 mm) long with insulated alligator clips at both ends. An ammeter can replace the jumper so the load ratings of the ignition transformer or valves (terminals 8, 9, 10, or 17) can be compared to their respective ratings.

General Instructions

1. Perform all applicable tests listed in the Static Checkout, Table 6, in the order listed.
2. Make sure all manual fuel shutoff valves are closed.
3. For each test, open the master switch and install the jumper wires between the subbase wiring terminals listed in the Test Jumpers column.
4. Close the master switch before observing the operation.
5. Read the voltage between the subbase wiring terminals listed in the Voltmeter column.
6. If there is no voltage or the operation is abnormal, check the circuits and external devices as described in the last column.
7. Check all wiring for proper connections, tight terminal screws, and appropriate wire and wiring techniques.
8. Replace all damaged or incorrectly sized wires.

- 9. Replace faulty controllers, limits, interlocks, actuators, valves, transformers, motors and other devices, as required.
- 10. Make sure normal operation is obtained for each required test before continuing the checkout.
- 11. After completing each test, be sure to remove the test jumper(s).

⚠ WARNING

Explosion Hazard.
Can cause serious injury or death.
 Be sure all manual fuel shutoff valves are closed.

IMPORTANT

Low fuel pressure limits, if used, could be open. Bypass them with jumpers for the remaining static tests (if required).

Table 6. Static Checkout.

Test No.	Test Jumpers	Voltmeter	Normal Operation	If Operation is Abnormal, Check the Items Listed Below
1	—	4-L2	Line Voltage.	1. Master switch. 2. Power connected to the master switch. 3. Overload protection (fuse, circuit breaker, etc.) has not opened the power line.
2	—	6-L2	Line Voltage.	1. Limits. 2. Burner control.
3	—	20-L2	Line Voltage	Preignition Interlock.
4	4-10	—	Ignition spark (if ignition transformer is connected to terminal 10).	1. Watch for spark or listen for buzz. a. Ignition electrodes are clean. b. Ignition transformer is okay.
5	4-8	—	1. Ignition spark (if ignition transformer is connected to terminal 8). 2. Automatic pilot valve opens (if connected to terminal 8). NOTE: Refer to wiring diagram of system being tested.	1. Watch for spark or listen for buzz: a. Ignition electrodes are clean. b. Ignition transformer is okay. 2. Listen for click or feel head of valve for activation: a. Actuator, if used. b. Pilot valve.
6	3-4	—	Alarm (if used) turns on.	1. Alarm.
7	4-9	—	Automatic fuel valve(s) opens. If using direct spark ignition, check the first stage fuel valve(s) instead of the pilot valve.	Same as test number 4. If using direct spark ignition, check the first stage fuel valve(s) instead of the pilot valve.
7a	—	16-L2	Line Voltage	Conduct after test 7. Valve Proving Switch should close to pressure trapped between Valves 1 and 2.
7b	4-17	—	Automatic Fuel Valve 2 opens.	
FINAL	<p>⚠ CAUTION Equipment Damage Hazard. Can cause serious equipment damage. After completing these tests, open the master switch, remove all test jumpers from the subbase terminals, and remove any bypass jumpers from the low fuel pressure limits to prevent equipment damage.</p>			

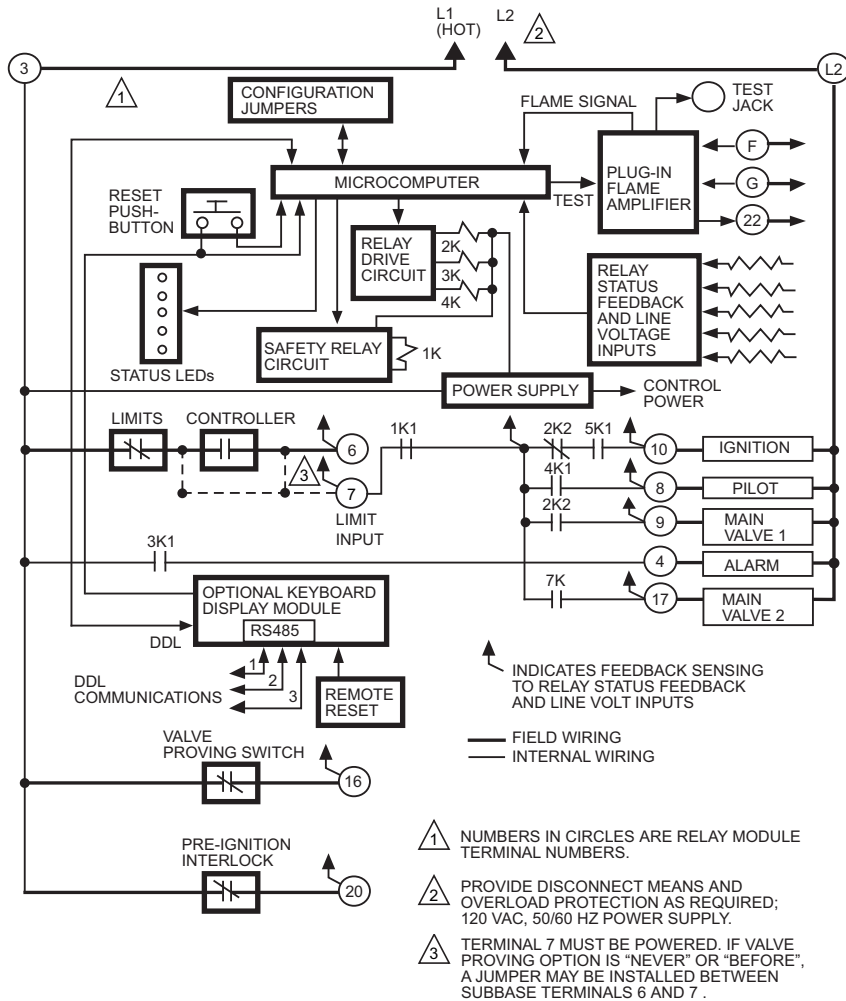

Fig. 3. Internal block diagram of the RM7890.

Mounting RM7890 Relay Module

1. Mount the RM7890 vertically on the Q7800 Subbase, or mount horizontally with the knife blade terminals pointing down. When mounted on the Q7800A, the RM7890 must be in an electrical enclosure.
2. When mounting in an electrical enclosure, provide adequate clearance for servicing, installation and removal of the RM7890, KDM, flame amplifier, flame amplifier signal voltage probes, electrical signal voltage probes, and electrical connections.
 - a. Allow an additional two inches (51 mm) below the RM7890 for flame amplifier mounting.
 - b. Allow an optional three-inch (76 mm) minimum to both sides of the RM7890 for electrical signal voltage probes.

3. Make sure no subbase wiring is projecting beyond the terminal blocks. Tuck in wiring against the back of the subbase so it does not interfere with the knife blade terminals or bifurcated contacts.

NOTE:

IMPORTANT

Install the RM7890 with a plug-in motion rather than a hinge action.

4. Mount the RM7890 by aligning the four L-shaped corner guides and knife blade terminals with the bifurcated contacts on the wiring subbase and securely tightening the two screws without deforming the plastic.
5. Mount the RM7890 by aligning the four L-shaped corner guides and knife blade terminals with the bifurcated contacts on the wiring subbase and securely tightening the two screws without deforming the plastic.

M23030A

Relay Module and Subbase Compatibility

NOTE: There are several different Relay models that can be purchased. It is important to note which Relay Module you are using and whether it is compatible with the Subbase. Refer to (the details on pg 3- or the pictures of the two different subbases) to determine compatibility.

Mounting Other System Components (Fig. 5)

Refer to the applicable specifications for mounting other system components.

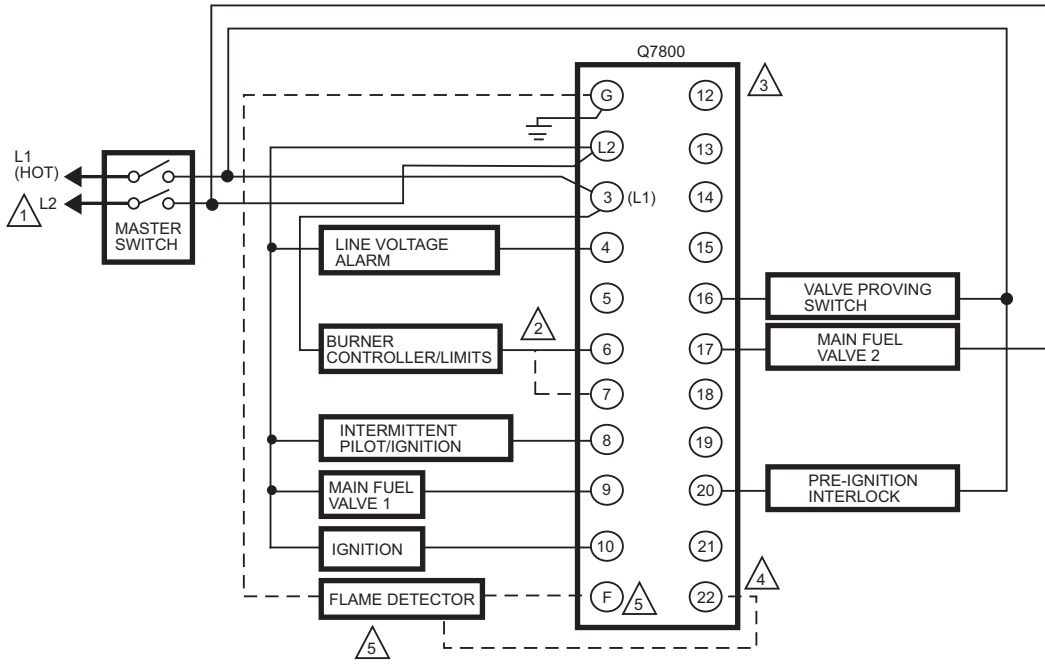

	00	00	4/10	20			
	INITIATE	STANDBY	SAFE-START	PFEP 4 OR 10 SEC	MFEP	RUN	STANDBY
LED DISPLAY	● POWER ○ ○ ○ ○	● POWER ○ ○ ○ ○	● POWER ○ ○ ○ ○	● POWER ● PILOT ● FLAME ○ MAIN ○ ALARM	● POWER ● PILOT ● FLAME ● MAIN ○ ALARM	● POWER ● PILOT ● FLAME ● MAIN ○ ALARM	● POWER ○ ○ ○ ○
BURNER START				IGNITION (10)			
				INTERMITTENT PILOT (8)			
				MAIN VALVE (9)			
OPERATING CONTROLLER AND LIMITS			LIMITS AND BURNER CONTROL CLOSED (3) TO (6)				
FLAME SIGNAL		SAFE START CHECK		FLAME PROVING		S S C	P I I
			PREIGNITION INTERLOCK (PII) (20)				

- 1 120V, 50/60 HZ POWER SUPPLY. PROVIDE DISCONNECT MEANS AND OVERLOAD PROTECTION AS REQUIRED.
- 2 TERMINAL 7 MUST BE POWERED. IF VALVE PROVING OPTION IS "NEVER" OR "BEFORE", A JUMPER BETWEEN SUBBASE TERMINALS 6 AND 7 MAY BE INSTALLED. IF SPLIT, BOTH OR AFTER OPTION IS USED, TERMINAL 7 SHOULD GET POWER FROM L1. CHECK LOCAL CODES REGARDING PLACEMENT OF LIMITS IN SERIES WITH THIS CONNECTION.
- 3 DO NOT CONNECT ANY WIRES TO UNUSED TERMINALS.
- 4 TERMINAL 22 IS ONLY ON THE RM7890B.
- 5 SEE FLAME DETECTOR SPECIFICATION FOR CORRECT WIRING.
- 6 TERMINAL 8 TURNS OFF IF JR3 IS CLIPPED.

M23031B

Fig. 4. Wiring subbase and operating sequence chart for RM7890.

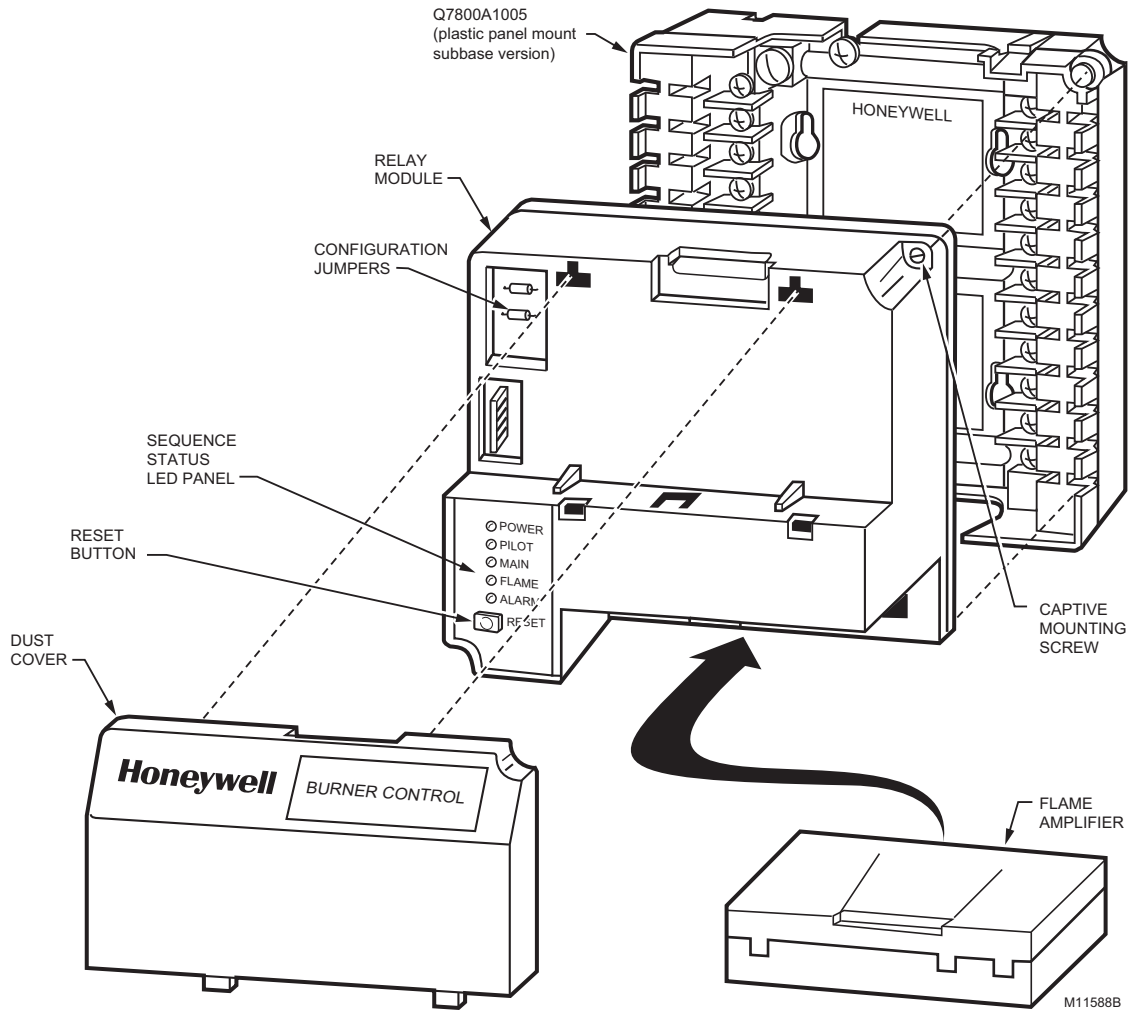

Fig. 5. RM7890 Relay Module exploded view.

VALVE PROVING SYSTEM

The Valve Proving System feature provides a systematic way of testing the valve seat integrity to assure the valves are in the closed state whenever the sequence of operation required them to be closed. It is designed to detect a leak greater than 0.1% of the burner input capacity. For example, a 10 million Btu/hr natural gas fueled burner would have a fuel capacity of approximately 1000 ft³/hr. A leak rate greater than 0.1% of 1000 ft³/hr or 1 ft³/hr in either valve will be detected with the Valve Proving System. Smaller leaks will not be detected.

At commissioning time, the Valve Proving System may be scheduled to occur at one of five different times: Never, Before, After, Both, and Split.

Never—Device Fault as received: in this case Valve Proving does not occur.

Before—Valve Proving occurs after Standby and Safe Start Check, but before Run.

After—Valve Proving occurs after the Run state before the internal Safety Relay dropout state.

Both—Valve proving occurs at both times Before and After noted above.

Split—The downstream (high pressure) seat test is performed at the Before time and the upstream (low pressure) seat test is performed during the After time.

The Valve Proving items programmed:

1. Enable Valve proving and when to perform it.
2. Define the time duration of the test is calculated using Appendix A.

Valve Proving Function

Valve proving consists of monitoring the pressure in the space between two shutoff valves, MV1 (upstream) and MV2 (downstream). The valve proving function, identified by letters A through G, operates as follows:

The tolerance on all valve proving timing values is ±10%.

The following are steps performed during valve proving tests. This section is for background information and does not define the exact behavioral requirements.

A. The RM7890 must have an input on terminal 7 (to power the valves for testing). If the Valve Proving Test is conducted After, Both or Split, terminal 7 must be powered from the L1 source.

B. MV2 is commanded to be open while MV1 remains closed; to depressurize the space. After four seconds, MV2 is commanded closed again.

C. This is followed by a three second delay during which the valve proving pressure switch (VPS) is ignored.

D. Thereafter, the VPS is monitored for the duration of the valve proving test time and, if it turns on, a lockout occurs. (Because the gas pressure has increased due to a leaky upstream valve [low pressure test].)

E. MV1 is commanded to be open, while MV2 remains closed, to pressurize the space. After four seconds, MV1 is commanded closed again.

F. This is followed by a three second delay, during which the valve proving pressure switch (VPS) is ignored.

G. Thereafter, the VPS is monitored for the duration of the valve proving test time and, if it turns off, a lockout occurs. (Because the gas pressure has decreased due to a leaky downstream valve [high pressure test].)

Pressure Switches for Valve Proving System

The Valve Proving System requires a pressure switch to be installed to monitor the pressure in the internal space between the two shutoff valves. Recommended pressure switches are the following Honeywell non-manual reset models:

Table 7. Honeywell Pressure Switch Selection for Valve Proving System.

1	2	3	4	5	6
Model Number	Operating Pressure Range	Maximum Differential (Additive)	Maximum Continuous Rated Pressure (psi)	Switch Action at Setpoint	Mounting Type
C6097A1004	0.4 to 5 in. wc	0.24 in. wc	2.9	Breaks N.O. to C connection on pressure fall.	1/4 in. NPT
C6097A1053	3 to 21 in. wc	0.48 in. wc	5.0		Flange
C6097A1061					1/4 in. NPT
C6097A1079	12 to 60 in. wc	2.4 in. wc	9.3		Flange
C6097A1087					1/4 in. NPT
C6097A1129	1.5 to 7 psi	0.3 psi	2.9		Flange
C6097A1137					1/4 in. NPT
C6097A1210	0.4 to 4 in. wc	0.24 in. wc			

Pressure Switch Selection

1. Determine the maximum operating inlet pressure for the upstream valve; for example, 5.0 psi (140 in. wc).
2. Divide the inlet pressure by two (2.5 psi [70 in. wc], for example).
3. From column 2 in Table 7 find the operating range upper limit that is closest to but greater than the inlet pressure divided by two. In the example given, the possible selections from column 1 are the C6097A1129 and C6097A1137 with an operating range upper limit of 7 psi. (The C6097A1079 and C6097A1087 with an upper limit of 60 in. wc are close, but 60 in. wc is less than the 70 in. wc minimum, so the next higher range must be selected.)
4. From column 6, select the preferred mounting type, 1/4 in. NPT or Flange. For example, if a flange mount is required, the pressure switch choice from column 1 would be the C6097A1137.

Pressure Switch Installation and Adjustment

1. Refer to the instructions for the C6097A Pressure Switch, form number 65-0237.
2. Install the C6097A Pressure Switch according to the instructions.
3. Adjust the setpoint to 50% of the maximum operating inlet pressure for the upstream valve.
4. Complete the operation and checkout procedures in the instructions.

Setup of Valve Proving Function

Prior to setup of the Valve Proving Function, follow the procedures in the appendix to complete the worksheet and obtain the Valve Proving Test Time.

An S7800A1142 Keyboard Display Module (KDM) is required for this setup and the RM7890 must have the Valve Proving function.

When the RM7890 is installed and powered, “STANDBY” will be shown on the first line of the display.

1. Scroll down until the “Setup” is displayed in the second line. (Setup is only available when the control is in Standby or Lockout state.)

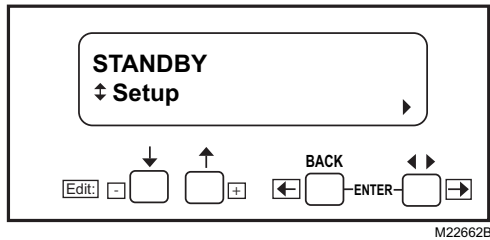

Fig. 6. STANDBY/Setup screen.

2. Enter the Setup submenu by pressing the far right key on the display. Note that the second line now reads “BC Password”.

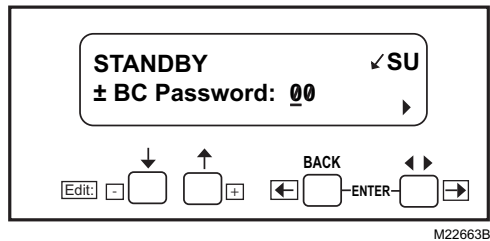

Fig. 7. Password screen.

3. Use the up/down arrows to enter the first number—7.
4. Use the far right key to shift over one space.
5. Use the up/down arrows to enter the second number 8.
6. Press ENTER (left/right arrow simultaneously).

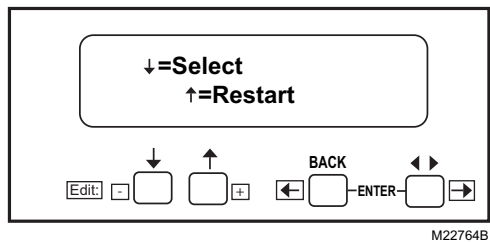

Fig. 8. Select/Restart screen.

7. To get to the next screen, press down arrow. “Getting Data” will be displayed, then the following screen.

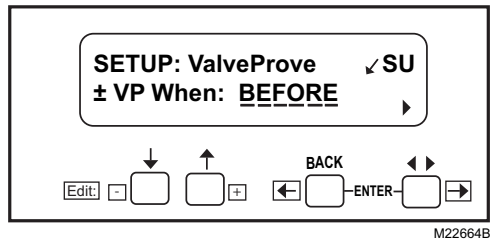

Fig. 9. SETUP: Valve Prove screen.

NOTE: This screen sets up when to do the Valve Proving Test.

8. Use the up/down arrows to select from Never, Before, After, Both, or Split, then press ENTER.

NOTE: Use Never on initial startup so gas line purging and System Checkout can be performed. Then come back to set final operation configuration. Be sure to conduct final checkout of VPS System when this setup is complete.

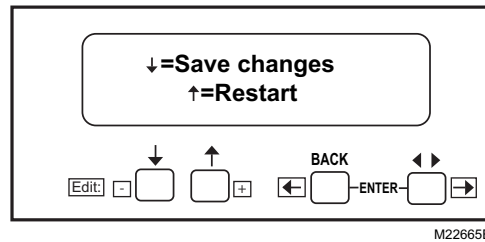

Fig. 10. Save Changes screen.

9. Use the down arrow to save changes. After pressing the down arrow, “Getting Data” is displayed.

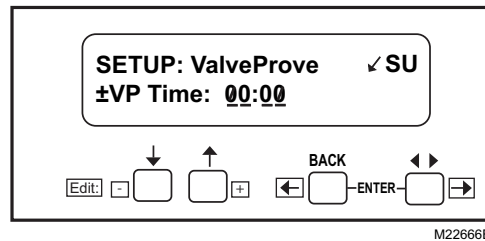

Fig. 11. Valve Prove time screen.

This screen sets up how long the RM7890 will conduct the Valve Proving Test for a given time. VP Time: 00:30 is shown.

10. Enter the appropriate Valve Proving test time from the worksheet in the appendix. Use the up arrow to increase time. Time increases:

- a. 0 to 60 seconds in 1-second intervals.
- b. 60 to 600 seconds in 10-second intervals.
- c. 10 to 60 minutes in 1-minute intervals.

NOTE: The minimum default test time is 10 seconds.

Press ENTER when correct time is displayed.

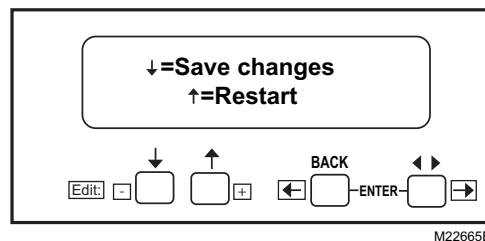

Fig. 12. Save Changes screen.

11. Use the down arrow to save changes. After pressing the down arrow, "Getting Data" is displayed.
12. Use down arrow to save changes. "Getting Data" is displayed.

The following steps are to confirm your selections.

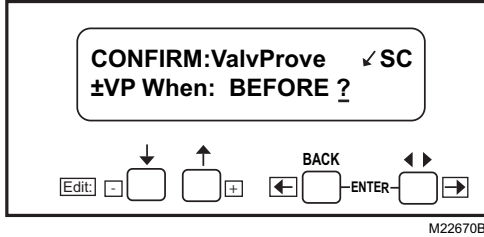

Fig. 13. Confirmation Acknowledgement screen.

13. Press ENTER. The Valve Proving test location is shown.

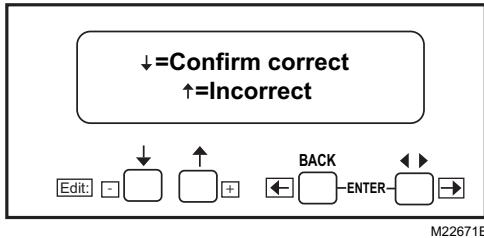

Fig. 14. Confirmation Correct screen.

14. Use the down arrow to confirm correct.

NOTE: Using the up arrow during the confirmation will take you back to the beginning of the setup routine.

"Getting Data" will be displayed, followed by the Selected Value Proving time.

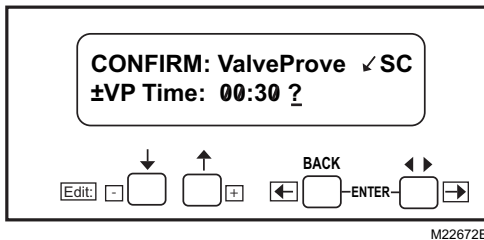

Fig. 15. Confirm screen.

15. Press ENTER.

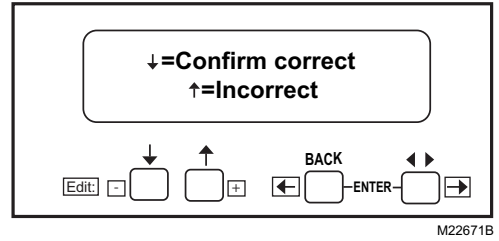

Fig. 16. Confirm Correct screen.

16. Use the down arrow to confirm correct. "Getting Data" will be displayed.

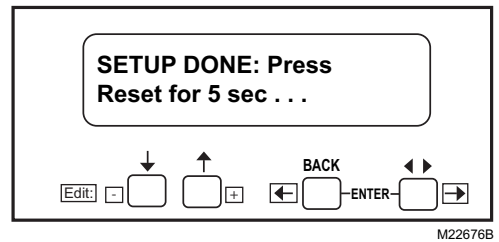

Fig. 17. Setup Done screen.

17. Go to the relay module and press and hold the RESET button for five seconds to program the Valve Proving setup into the relay module. The Release Reset screen will appear on the KDM.

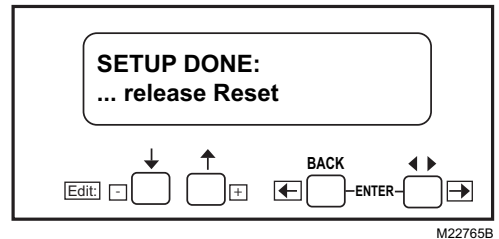

Fig. 18. Release Reset screen.

Changing the Valve Proving features is still possible. With the relay module in Start Switch, scroll to the Setup line and enter the password to change the settings.

Once the system is in operation, the settings of the Valve Proving can be viewed un Diagnostics, using your S7800 Keyboard Display Module (KDM).

BEFORE

	4 SEC.	3 SEC.	TEST TIME	4 SEC.	3 SEC.	TEST TIME	IGNITION TRIALS	
CONTROLLER	L1-6							
	L1-7							
	MV2 (17)							
					MV1 (9)			
				VPS (16)				VPS (16)
	PII (20)		PII (20)			PII (20)		

AFTER

	RUN	4 SEC.	3 SEC.	TEST TIME	4 SEC.	3 SEC.	TEST TIME	STANDBY	
CONTROLLER	L1-6								
	L1-7								
	MV2 (17)						MV1 (9)		
				VPS (16)				VPS (16)	
					PII (20)				

SPLIT

	STANDBY	4 SEC.	3 SEC.	TEST TIME	BURNER RUN TIME	4 SEC.	3 SEC.	TEST TIME	STANDBY	
CONTROLLER	L1-6									
	L1-7									
	MV1 (9)						MV2 (17)			
				VPS (16)				VPS (16)		
					PII (20)					

- LOCKOUT IF ON, M1 LEAKING (LOW PRESSURE TEST).
- LOCKOUT IF OFF, MV2 LEAKING (HIGH PRESSURE TEST).

M22669E

Fig. 19. RM7890 Sequence for Valve Proving System.

PRINCIPAL TECHNICAL FEATURES

The RM7890 provides all customary flame safeguard functions as well as significant advancements in safety, annunciation, and system diagnostics.

Safety Shutdown (Lockout) Occurs if:

1. INITIATE PERIOD
 - a. AC line power errors occurred, see Operation.
 - b. Configuration jumpers have been changed (after 200 hours).
 - c. Four minute INITIATE period has been exceeded.
2. STANDBY PERIOD
 - a. Flame signal is present after 240 seconds.
 - b. Ignition/pilot valve terminal is energized.
 - c. Internal system fault occurred.
 - d. Main valve terminal (1 or 2) is energized.
 - e. Three second Flame Failure Response Time (FFRT) Amplifier is installed and configuration jumper is selected for relight (see Table 3).
 - f. Pre-Ignition Interlock opens after 30 seconds.
3. SAFE START CHECK
 - a. Ignition/pilot valve terminal is energized.
 - b. Internal system fault occurred.
 - c. Main valve terminal (1 or 2) is energized.
 - d. Pre-Ignition Interlock opens.
4. PILOT FLAME ESTABLISHING PERIOD (PFEP)
 - a. Ignition/pilot valve terminal is not energized.
 - b. Internal system fault occurred.

- c. Main valve terminal (1 or 2) is energized.
- d. No flame present at end of PFEP.
5. RUN PERIOD
 - a. Ignition terminal is energized.
 - b. Internal system fault occurred.
 - c. Main valve terminal (1 or 2) is not energized.
 - d. No flame present and configuration jumper is selected for lockout.
 - e. Pilot valve terminal is not energized (Intermittent Operation).
 - f. Pilot Valve terminal is energized (Interrupted Operation selected).

OPERATION

Sequence of Operation

The RM7890 has the operating sequences listed below; see Fig. 3. The RM7890 LED provide positive visual indication of the program sequence: POWER, PILOT, FLAME, MAIN and ALARM.

Initiate

The RM7890 enters the INITIATE sequence when the relay module is powered. The RM7890 can also enter the INITIATE sequence if the relay module verifies voltage fluctuations of +10/-15% or frequency fluctuations of ±10% during any part of the operating sequence. The INITIATE sequence lasts for ten seconds unless the voltage or frequency tolerances are not met. When the tolerances are not met, a hold condition is initiated and is displayed on the optional KDM for at least five seconds.

When the tolerances are met, the INITIATE sequence restarts. If the condition is not corrected and the hold condition exists for four minutes, the RM7890 locks out. Causes for hold conditions in the INITIATE sequence:

- a. AC line dropout detection.
- b. AC line noise that can prevent a sufficient reading of the line voltage inputs.
- c. Brownouts caused by a low line voltage.

NOTE: If a 3.0 second flame failure response amplifier is installed and configuration jumper JR2 is intact, the RM7890 locks out. JR2 must be clipped.

Standby

The RM7890 is ready to start an operating sequence when the operating control input (terminal 6) recognizes a call for heat. The burner switch, limits, operating limit control and all microcomputer monitored circuits must be in the correct state for the RM7890 to continue into the Safe Start Check. The RM7890 must also have an input on terminal 7.

Normal Start-Up Safe Start Check

The RM7890 verifies that a flame or flame simulating condition does not exist and proceeds into the Ignition Trial. If a flame or flame simulating condition is present, the RM7890 remains in the STANDBY period.

Valve Proving occurs here if Before, Both, or Split sequence is selected.

Ignition Trials

- a. Pilot Flame Establishing Period (PFEP):
 - (1) The pilot valve and ignition transformer, terminals 8 and 10, are energized. The RM7890 has an intermittent pilot valve, terminal 8. (Interrupted if JR3 is removed).
 - (2) Flame must be proven by the end of the four- or ten-second PFEP or a safety shutdown occurs.
 - (3) Once flame is proven:
 - (a) Intermittent—the ignition, terminal 10, is de-energized and the main valves, terminal 9 and 17, are energized.
 - (b) Interrupted—at the end of the timed PFEP, terminal 10 is de-energized and the main Valve 1 (terminal 9) and main valve 2 (terminal 17) are energized. After a 10-second Main Flame Establishing time, the Pilot Valve (terminal 8) is de-energized.

Run

The RM7890 is now in RUN and remains in RUN until the controller input, terminal 6, opens, indicating that the demand is satisfied or a limit has opened.

The Pre-Ignition Interlock must close five seconds after terminal 6 opens. (It is ignored during Valve-On time in the Valve Proving Sequence if After, Split, or Both option is chosen for Valve Proving tests.) Pre-Ignition Interlock input is required five seconds after the valve output is de-energized.

SETTINGS AND ADJUSTMENTS

Selectable Site-Configurable Jumpers

The RM7890 has two site-configurable jumper options, see Fig. 20 and Table 7. If necessary, clip the site-configurable jumpers with side cutters and remove the resistors from the relay module.

SERVICE NOTE

Clipping and removing a site-configurable jumper enhances the level of safety. If using three-second amplifier, site-configurable jumper JR2 must be clipped and removed. If not removed, an F46 Lockout occurs.

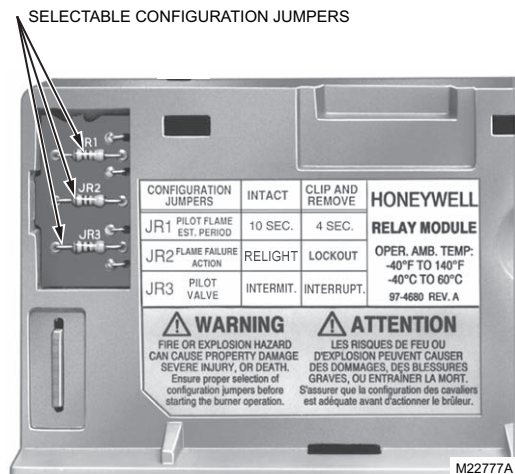

Fig. 20. Selectable site-configurable jumpers.

Table 8. Site-Configurable Jumper Options.

Jumper Number	Description	Intact	Clipped ^b
JR1	Pilot Flame Establishing Period (PFEP)	10 seconds	4 seconds
JR2	Flame Failure Action	Relight ^a	Lockout
JR3	Pilot Valve (T8)	Intermittent	Interrupted

^a The Relight feature (JR2 intact) requires a 0.8 second FFRT Flame Amplifier. The RM7890 locks out and indicates a Fault 46 if a 3 second FFRT is used and jumper JR2 is not clipped and removed.

^b Clipping and removing a site-configurable jumper after 200 hours of operation results in a hard lockout, code 110.

SYSTEM CHECKOUT

IMPORTANT

Perform Static Checkout Procedures before starting these procedures.

WARNING

Explosion Hazard.
Can cause severe injury, death or property damage.

1. Do not allow fuel to accumulate in the combustion chamber for longer than a few seconds without igniting to prevent danger of forming an explosive mixture.
2. Close manual fuel shutoff valve(s) if flame is not burning at the end of the specified time.

WARNING

Electrical Shock Hazard.
Can cause severe injury, death or property damage.

1. Use extreme care when testing system. Line voltage is present on most terminal connections when power is on.
2. Open the master switch before removing or installing the 7800 SERIES Relay Module or Keyboard Display Module connector.

1. Make sure all manual fuel shutoff valve(s) are closed before starting initial lightoff check and Pilot Turn-down tests.
2. Do not put the system into service until you have satisfactorily completed all applicable tests in this section and any others recommended by the original equipment manufacturer.
3. Limit trial for pilot to ten seconds. Limit the attempt to light main burner to two seconds after fuel reaches the burner nozzle. Do not exceed manufacturer nominal lightoff time.

IMPORTANT

1. If the system fails to perform properly, note the fault code, fault message, equipment status, and sequence time on the display. Then refer to the Troubleshooting section.
2. Repeat all required Checkout tests after all adjustments are made. All tests must be satisfied with the flame detector(s) in their final positions.

Equipment Recommended

1. S7800 Keyboard Display Module
2. Volt-ohmmeter (1 Megohm/volt minimum sensitivity) with:
 - a. 0-300 Vac capability.
 - b. 0-6000 ohm capability.
 - c. 0-10 Vdc capability.

Checkout Summary

Table 8 provides an overview of checkout steps performed for each applicable system.

See the Installation instructions for location of component parts and/or Q7800 specifications for terminal locations.

Table 9. Checkout Steps and Applicable 7800 Series Systems.

Checkout Step	Piloted Systems	Infrared Flame Detectors	Flame Rod Systems	Ultraviolet Flame Detectors
Preliminary Inspection	X	X	X	X
Flame Signal Measurement	X	X	X	X
Initial Lightoff Check for Proved Pilot	X			
Pilot Turndown Test	X			
Ignition Interference Test			X	
Hot Refractory Saturation Test		X		
Hot Refractory Hold-in Test	X	X	X	X
Ignition Spark Pickup				X
Response to Other Ultraviolet Sources				X
Flame Signal with Hot Combustion Chamber	X	X	X	X
Safety Shutdown Tests	X	X	X	X

Preliminary Inspection

Perform the following inspections to avoid common

problems. Make certain that:

1. Wiring connections are correct and all terminal screws are tight.
 2. Flame detector(s) is (are) clean, installed and positioned properly. Consult the applicable instructions.
 3. Combination of amplifier and flame detector(s) is correctly used. See the amplifier specifications.
 4. Burner is completely installed and ready to fire; consult equipment manufacturer instructions.
 5. Fuel lines are purged of air.
 6. Combustion chamber and flues are clear of fuel and fuel vapor.
 7. Power is connected to the system disconnect switch (master switch).
 8. Lockout is reset (reset button) only if the Relay Module is powered.
 9. Run/Test Switch (if present) is in the RUN position.
 10. System is in STANDBY condition. STANDBY message is displayed in the S7800 Keyboard Display Module.
 11. All limits and interlocks are reset.
- a. Open the master switch and remove the 7800 SERIES Relay Module from the subbase.
 - b. On the subbase, jumper L1 to the ignition terminal; refer to the appropriate wiring diagram to determine the proper terminal. Disconnect the leadwire to the pilot valve if it is connected to the same terminal.
 - c. Close the master switch to energize only the ignition transformer.
 - d. If the ignition spark is not strong and continuous, open the master switch and adjust the ignition electrode spark gap setting to the manufacturer recommendation.
 - e. Make sure the ignition electrodes are clean.
 - f. Close the master switch and observe the spark.
 - g. After a continuous spark is obtained, open the master switch and add a jumper on the subbase from terminal L1 power to the pilot terminal 8. Reconnect the leadwire from the pilot valve if it was disconnected in step b.
 - h. Close the master switch to energize both the ignition transformer and the pilot valve.
 - i. If the pilot does not ignite and if the ignition spark is still continuous, adjust the pressure regulator until a pilot is established.
 - j. When the pilot ignites properly and stays ignited, open the master switch and remove the jumper(s) from the terminals of the subbase.
 - k. Check for adequate bleeding of the fuel line.
 - l. Reinstall the 7800 SERIES Relay Module on the subbase, close the master switch and return to step 4.

Flame Signal Measurement

See instructions provided with the amplifier.

INITIAL LIGHTOFF CHECKS

Proved Pilot Systems

Perform this check on all installations that use a pilot. It should immediately follow the preliminary inspection.

Low fuel pressure limits, if used, could be open. If so, bypass them with jumpers during this check.

1. Open the master switch.
2. Make sure the manual main fuel shutoff valve(s) is(are) closed. Open the manual pilot shutoff valve. If the pilot takeoff is downstream from the manual main fuel valve(s), slightly open the main valve to supply pilot gas flow. Make sure the main fuel is shut off just upstream from the burner inlet, or disconnect power from the automatic main fuel valve(s).
3. Close the master switch and start the system with a call for heat by raising the setpoint of the operating controller; see the relay module sequence. The 7800 SERIES Relay Module should start the INITIATE sequence.
4. Let the sequence advance to PILOT IGN (status is displayed on the Keyboard Display Module, if used). PILOT LED turns on, ignition spark should occur and the pilot should light. If the pilot ignites, the FLAME LED is energized. Go to step 7.
5. If the pilot flame is not established in ten seconds (four seconds if configuration jumper JR1 is clipped), safety shutdown occurs. Let the sequence complete its cycle.
6. Push the reset pushbutton, and let the system recycle once. If the pilot still does not ignite, make the following ignition/pilot adjustments:
 7. When the pilot ignites, measure the flame signal. If the pilot flame signal is unsteady or approaching the 1.25 Vdc minimum value, adjust the pilot flame size or detector sighting to provide a maximum and steady flame signal.
 8. Recycle the system to recheck lightoff and pilot flame signal.
 9. When the MAIN LED turns on, make sure the automatic main fuel valve is open; then smoothly open the manual main fuel shutoff valve(s) and watch for main burner flame ignition. When the main burner flame is established, go to step 16.
 10. If the main burner flame is not established within five seconds or the normal lightoff time as specified by the equipment manufacturer, close the manual main fuel shutoff valve(s).
 11. Recycle the system to recheck the lightoff and pilot flame signal.
 12. Smoothly open the manual fuel shutoff valve(s) and try lightoff again. (The first re-attempt may have been required to purge the lines and bring sufficient fuel to the burner.)
 13. If the main burner flame is not established within five seconds or the normal lightoff time specified by the equipment manufacturer, close the manual main fuel shutoff valve(s). Check all burner adjustments.
 14. If the main burner flame is not established after two attempts:
 - a. Check for improper pilot flame size.
 - b. Check for excess combustion air at low fire.
 - c. Check for adequate low fire fuel flow.
 - d. Check for proper gas supply pressure.
 - e. Check for proper valve operation.
 - f. Check for proper pilot flame positioning.

15. Repeat steps 8 and 9 to establish the main burner flame; then go to step 16.
16. With the sequence in RUN, make burner adjustments for flame stability and Btu input rating.
17. Shut down the system by opening the burner switch or by lowering the setpoint of the operating controller.
18. Restart the system by closing the burner switch and/or raising the setpoint of the operating controller. Observe that the pilot is established during PILOT IGN and the main burner flame is established during MAIN IGN within the normal lightoff time.
19. Measure the flame signal. Continue to check for the proper signal through the RUN period. Check the signal at both High and Low Firing Rate positions and while modulating, if applicable.
20. Run the burner through another sequence, observing the flame signal for:
 - a. Pilot flame alone.
 - b. Pilot and main flame together.
 - c. Main flame alone (unless monitoring an intermittent pilot). Also, observe the time it takes to light the main flame. Ignition of main flame should be smooth.
21. Make sure all readings are in the required ranges before proceeding.
22. Return the system to normal operation.

NOTE: After completing these tests, open the master switch and remove all test jumpers from the subbase terminals, limits/controls or switches.

PILOT TURNDOWN TEST (ALL INSTALLATIONS USING A PILOT)

Perform this test on all installations that use a pilot. The purpose of this test is to verify that the main burner can be lit by the smallest pilot flame that can hold in the flame amplifier and energize the FLAME LED. Clean the flame detector(s) to make sure that it detects the smallest acceptable pilot flame.

If using AMPLI-CHECK™ or self-checking amplifier and 1M ohm/volt meter, the flame signal fluctuates every time the amplifier does a self-check or a shutter check.

NOTE: Low fuel pressure limits, if used, could be open. If so, bypass them with jumpers during this test.

1. Open the master switch.
2. Close the manual main fuel shutoff valve(s).
3. Connect a manometer (or pressure gauge) to measure pilot gas pressure during the turndown test.
4. Open the manual pilot shutoff valve(s).
5. Close the master switch and start the system with a call for heat. Raise the setpoint of the operating controller. The 7800 SERIES sequence should start, and PREPURGE, if applicable, should begin.
6. After the PILOT LED turns on interrupted pilot applications, set the Run/Test Switch to the TEST position to stop the sequence. The FLAME LED comes on when the pilot ignites.

NOTE: If the sequence does not stop, reset the system and make sure you set the Run/Test Switch to TEST within the first eight seconds of the PILOT IGN sequence.

IMPORTANT

You have 0.8 second or three seconds, depending on the PFEP selected, to position the Run/Test Switch to the TEST position to stop the sequence after the start of the PILOT IGN period.

7. Turn down the pilot pressure very slowly, reading the manometer (or pressure gauge) as it drops. Stop instantly when the FLAME LED goes out. Note the pressure. The pilot is at the minimum turndown position. Immediately turn up the pilot pressure until the FLAME LED comes on again or the flame signal increases to 1.25 Vdc.

NOTE: If there is no flame for 15 seconds, with the RUN/TEST Switch in the TEST position, the relay module locks out.

8. Repeat step 7 to verify the pilot gas pressure reading at the exact point the FLAME LED goes out.
9. Increase the pilot pressure immediately until the FLAME LED comes on, and then turn it down slowly to obtain a pressure reading just above the dropout point or until the flame signal increases to 1.25 Vdc.
10. Set the Run/Test Switch in the RUN position (if used) and let the sequence proceed. When the MAIN LED turns on, make sure the automatic main fuel valve(s) opens; then smoothly open the manual main fuel shutoff valve(s) (or any other manually-opened safety shutoff valve(s), if used) and watch for main burner ignition. If the main burner flame is established, go to step 18.

NOTE: This step requires two people, one to open the manual valve(s) and one to watch for ignition.

11. If the main burner flame is not established within five seconds, or within the normal lightoff time specified by the equipment manufacturer, close the manual main fuel shutoff valve(s) and open the master switch. If the lightoff is rough, the pilot flame size is too small.
12. Close the master switch to recycle the burner and stop the sequence in the PILOT period by using the Run/Test Switch.
13. Increase the pilot flame size by increasing its fuel flow until a smooth main flame is accomplished.
14. Reposition the flame scanner sight tube or use orifices until the pilot flame signal voltage is in the range of 1.25 to 1.50 Vdc.
15. When the main burner lights reliable with the pilot at turndown, disconnect the manometer (or pressure gauge) and turn up the pilot gas flow to that recommended by the equipment manufacturer.
16. If used, remove the bypass jumpers from the subbase terminals, limits/controls, or switches.
17. Run the system through another cycle to check for normal operation.
18. Return the system to normal operation.

IGNITION INTERFERENCE TEST (ALL FLAME RODS)

Ignition interference can subtract from (decrease) or add to (increase) the flame signal. If it decreases the flame signal enough, it causes a safety shutdown. If it increases the flame signal, it could cause the FLAME LED to come on when the true flame signal is below the minimum acceptable value.

Start the burner and measure the flame signal with both ignition and pilot (or main burner) on, and then with only the pilot (or main burner) on. Any significant difference (greater than 0.5 Vdc) indicates ignition interference.

To Eliminate Ignition Interference

1. Make sure there is enough ground area.
2. Be sure the ignition electrode and the flame rod are on opposite sides of the ground area.
3. Check for correct spacing on the ignition electrode:
 - a. 6000V systems—1/16 to 3/32 in. (1.6 to 2.4 mm).
 - b. 10,000V systems—1/8 in. (3.2 mm).
4. Make sure the leadwires from the flame rod and ignition electrode are not too close together.
5. Replace any deteriorated leadwires.
6. If the problem cannot be eliminated, consider changing the system to an ultraviolet flame detection system.

HOT REFRACTORY TESTS

Hot Refractory Saturation Test (All Infrared Detectors)

Start the burner and monitor the flame signal during the warm-up period. A decrease in signal strength as the refractory heats up indicates hot refractory saturation. If saturation is extreme, the flame signal drops below 1.25 Vdc and the system shuts down as though a flame failure occurred.

If hot refractory saturation occurs, the condition must be corrected. Add an orifice plate in front of the cell to restrict the viewing area, lengthen the sight pipe, or decrease the pipe size (diameter). Continue adjustments until hot refractory saturation is eliminated.

Hot Refractory Hold-in Test (Rectifying Photocell, Infrared Detectors, Ultraviolet Detectors)

This condition can delay response to flame failure and also can prevent a system restart if hot refractory is detected.

Infrared (lead sulfide) detectors can respond to infrared rays emitted by a hot refractory, even when the refractory has visibly ceased to glow. Infrared radiation from a hot refractory is steady, but radiation from a flame has a flickering characteristic. The infrared detection system responds only to flickering infrared radiation; it can reject a steady signal from hot refractory. The refractory steady

signal can be made to fluctuate if it is reflected, bent or blocked by smoke or fuel mist within the combustion chamber. Be careful when applying an infrared system to verify its response to flame only.

The ultraviolet detector can respond to hot refractory above 2300°F (1371°C).

1. Operate the burner until the refractory reaches its maximum temperature (Infrared Only). If the installation has a multi-fuel burner, burn the heavier fuel that is most likely to reflect, bend or obscure the hot refractory steady infrared radiation.
2. When the maximum refractory temperature is reached, close all manual fuel shutoff valves, or open the electrical circuits of all automatic fuel valves.
3. Visually observe when the burner flame or FLAME LED goes out. If this takes more than three seconds, the infrared detector is sensing hot refractory.
4. Immediately terminate the firing cycle. Lower the setpoint to the operating controller, or set the Fuel Selector Switch to OFF. *Do not open the master switch.*

NOTE: Some burners continue to purge oil lines between the valves and nozzles even though the fuel valves are closed. Terminating the firing cycle (instead of opening the master switch) allows purging the combustion chamber. This reduces a buildup of fuel vapors in the combustion chamber caused by oil line purging.

5. If the detector is sensing hot refractory, correct the condition by one or more of the following procedures:
 - a. Add an orifice plate in front of the cell to restrict the viewing area of the detector.
 - b. Resight the detector at a cooler, more distant part of the combustion chamber. Make sure the detector properly sights the flame.
 - c. Try lengthening the sight pipe or decreasing the pipe size (diameter).

For details, refer to the detector Instructions and the equipment Operating Manual. Continue adjustments until hot refractory hold-in is eliminated.

IGNITION SPARK RESPONSE TEST (ALL ULTRAVIOLET DETECTORS)

Test to make certain that the ignition spark is not actuating the FLAME LED:

1. Close the pilot and main burner manual fuel shutoff valve(s).
2. Start the burner and use the Run/Test Switch (if available) to stop the sequence in the PILOT IGN period. Ignition spark should occur, but the flame signal should not be more than 0.5 Vdc.
3. If the flame signal is higher than 0.5 Vdc and the FLAME LED does come on, consult the equipment operating manual and resight the detector farther out from the spark, or away from possible reflection. It may be necessary to construct a barrier to block

the ignition spark from the detector view. Continue adjustments until the flame signal due to ignition spark is less than 0.5 Vdc.

NOTE: The Honeywell Q624A and Q652A,B Solid State Spark Generators prevent detection of ignition spark when properly applied with C7027, C7035,C7044 or C7061 Ultraviolet Flame Detectors. The Q624A and Q652B are only for use with gas pilots; the Q652A is only for oil applications.

Response to Other Ultraviolet Sources

Some sources of artificial light (such as incandescent or fluorescent bulbs, mercury sodium vapor lamps and daylight) produce small amounts of ultraviolet radiation. Under certain conditions, an ultraviolet detector responds to these sources as if sensing a flame. To check for proper detector operation, check the Flame Failure Response Time (FFRT) and conduct Safety Shutdown Tests under all operating conditions.

Flame Signal With Hot Combustion Chamber (All Installations)

1. With all initial start-up tests and burner adjustments completed, operate the burner until the combustion chamber is at the maximum expected temperature.
2. Observe the equipment manufacturer warm-up instructions.
3. Recycle the burner under these hot conditions and measure the flame signal. Check the pilot alone, the main burner flame alone, and both together (unless monitoring only the pilot flame when using an intermittent pilot). Check the signal at both High and Low Firing Rate positions and while modulating, if applicable.
4. Check the FFRT of the flame amplifier and relay module.
5. Lower the setpoint of the operating controller and observe the time it takes for the burner flame to go out. This should be within the maximum FFRT.
6. If the flame signal is too low or unsteady, check the flame detector temperature. Relocate the detector if the temperature is too high.
7. If necessary, realign the sighting to obtain the proper signal and response time.
8. If the response time is still too slow, replace the Plug-in Flame Signal Amplifier.
9. If the detector is relocated or resighted, or the amplifier is replaced, repeat all required Checkout tests.

SAFETY SHUTDOWN TESTS (ALL INSTALLATIONS)

Perform these tests at the end of Checkout, after all other tests are completed. If used, the external alarm should turn on. Press the RESET push button on the relay module to restart the system.

1. Opening a Preignition Interlock during STANDBY.
 - a. *Preignition ILK* fault is displayed on the Keyboard Display Module (KDM). Fault code 10 or 33 is displayed to denote the fault.
 - b. Safety shutdown occurs.
2. Detection of flame 40 seconds after entry to STANDBY from RUN, fault code 9. Detection of flame from 10 seconds up to 30 seconds into PREPURGE time.
 - a. Simulate a flame to cause the flame signal voltage level to be at least 1.25 Vdc for 40 seconds after entry to STANDBY from RUN.
 - b. *Flame Detected* fault is displayed on the Keyboard Display Module. Fault code 9 or 15 or 18 is displayed to denote the fault.
 - c. Safety shutdown occurs.
3. Failure to ignite pilot.
 - a. Close pilot and main fuel manual shutoff valve(s).
 - b. Cycle burner on.
 - c. Automatic pilot valve(s) should be energized but the pilot cannot ignite.
 - d. *Pilot Flame Fail* fault is displayed on the Keyboard Display Module. Fault code 28 is displayed four or ten seconds, depending on the jumper configuration selection for Pilot Flame Establishing Period (PFEP) after the pilot valve(s) is energized to denote the fault.
 - e. Safety shutdown occurs.
4. Failure to ignite main (only interrupted pilot application).
 - a. Open the manual pilot valve(s); leave the main fuel manual shutoff valve(s) closed.
 - b. Depress the RESET button.
 - c. Start the system.
 - d. The pilot should ignite and the flame signal should be at least 1.25 Vdc but the main burner cannot light.
 - e. The flame signal should drop below 1.25 Vdc within the FFRT of the amplifier and the relay module after the interrupted pilot goes out.
 - f. *Main Flame Ign.* fault is displayed on the Keyboard Display Module. Fault code 19 is displayed to denote the fault.
 - g. Safety shutdown occurs.
5. Loss of flame during RUN.
 - a. Open the main fuel manual shutoff valve(s) and open manual pilot shutoff valve(s).
 - b. Depress the RESET button.
 - c. Start the system. Start-up should be normal and the main burner should light normally.
 - d. After the sequence is in the normal RUN period for at least 10 seconds with the main burner firing, close the manual main shutoff valve(s) to extinguish the main burner flame. (On intermittent pilot applications, also, close the pilot manual shutoff valve[s].)
 - e. The flame signal should drop below 1.25 Vdc within the FFRT of the amplifier and the relay module after the main flame and/or pilot goes out.
 - f. *Main Flame Fail* fault is displayed on the Keyboard Display Module. Fault code 17 is displayed to denote the fault.
 - g. Safety shutdown occurs. (RM7890 Relay Modules will recycle if jumper JR2 is intact, then lock out on failure to light the pilot.)

6. Opening a Preignition Interlock after the first five seconds of STANDBY.
 - a. Open the main fuel manual shutoff valve(s) and open manual pilot shutoff valve(s).
 - b. Depress the RESET button.
 - c. *Preignition ILK* fault is displayed on the Key-board Display Module. Fault code 33 is displayed to denote the fault.
 - d. Safety shutdown occurs.

IMPORTANT

1. *If the relay module fails to shut down on any of these tests, take corrective action; refer to Troubleshooting and the relay module diagnostic and return to the beginning of all Checkout tests.*
2. *When all Checkout tests are completed, reset all switches to the original status.*

TROUBLESHOOTING

The POWER LED provides fault identification when the Relay Module locks out on an alarm. Fault identification is a series of fast- and slow-blinking LED lights. The fast blinks identify the tens portion of the fault code (three fast blinks is 30), while the slow blinks identify the units portion of the fault code (two slow blinks is 2). Three fast blinks followed by two slow blinks would be fault code 32. (See Table 9 for Blinking Fault Code List.)

The LED code repeats as long as the fault exists. To clear the fault, press the RESET button.

The S7800 KDM displays a sequence status message indicating: STADBY, PURGE, PILOT IGN, MAIN IGN, RUN and POSTPURGE. The selectable messages also provide visual indication of current status and historical status of the equipment, such as: Flame Signal, Total Cycles, Total Hours, Fault History, Diagnostic Information, and Expanded Annunciator terminal status (if used). With this information, most problems can be diagnosed without extensive trial and error testing.

Diagnostic Information and History Data are available to assist in troubleshooting the relay module.

The relay module provides diagnostic information to aid the service mechanic in obtaining information when troubleshooting the system. Information available in the Diagnostic Information includes Device Type, Device Suffix, Software Revision, Manufacturing Code, Flame

Amplifier Type, Flame Failure Response Time, Selectable Jumper Configuration Status, Run/Test Switch Status and Terminal Status.

Diagnostic Information Index

The relay module monitors input/output terminals and can display the status of the terminal at the KDM (example: Pilot Valve T8 1). See the applicable relay module installation instructions for a complete terminal description and number. The display shows the actual status of the terminal. If voltage is detected at the terminal, 1 is displayed, but if no voltage is detected at the terminal, 0 is displayed.

Historical Information Index

The relay module has nonvolatile memory that allows the relay module to retain historical information for the six most recent lockouts. Each of the six lockout files retains the cycle when the fault occurred, the hour of operation when the fault occurred, a fault code, a fault message and burner status when the fault occurred.

IMPORTANT

Some older relay modules cannot operate without a KDM, extension cable assembly with KDM, or a Data ControlBus™ Module installed.

SERVICE NOTES:

1. If the KDM is scrambled, remove and reinstall the KDM, and reset the 7800 SERIES Relay Module.
2. Reset the 7800 SERIES Relay Module by pressing the RESET pushbutton on the 7800 SERIES Relay Module, or by pressing a remote reset pushbutton wired through the KDM, Data ControlBus™ Module, or Remote Reset Module. A power-up reset causes an electrical reset of the relay module but does not reset a lockout condition.
3. Use the access slots in the sides of the Q7800A,B Wiring Subbase to check terminal voltage.
4. Maximum ambient temperature of a C7012E,F;Series 1 through 6, is reduced to 125°F because of the duty cycle operation of the relay module.

Table 10. Blinking Fault Codes and Recommended Troubleshooting .

Blink Code	System Failure	Recommended Troubleshooting
Code 1-1 *Low AC Line Voltage*	Low AC Line detected.	<ol style="list-style-type: none"> 1. Check the relay module and display module connections. 2. Reset and sequence the Relay Module. 3. Check the 7800 power supply and make sure that frequency and voltage meet specifications. 4. Check the backup power supply, as appropriate.
Code 1-2 *AC Quality Problem*	Excessive noise or device running on slow, fast, or AC line dropout detected.	
Code 2-1 *Unexpected Flame Signal*	Flame sensed when no flame is expected during STANDBY or PURGE.	<ol style="list-style-type: none"> 1. Check that flame is not present in the combustion chamber; correct any errors. 2. Make sure that the flame amplifier and flame detector are compatible. 3. Check the wiring and correct any errors. 4. Remove the flame amplifier and inspect its connections. Reseat the amplifier. 5. Reset and sequence the relay module. 6. If the code reappears, replace the flame amplifier and/or the flame detector. 7. If the fault persists, replace the relay module.
Code 2-2 *Flame Signal Absent*	No-flame time present at the end of the Pilot Flame Establishing Period; lost during the Main Flame Establishing Period or during RUN.	<ol style="list-style-type: none"> 1. Measure the flame signal. If one exists, verify that it meets specifications. 2. Make sure that the flame amplifier and flame detector are compatible. 3. Inspect the main fuel valve(s) and valve connection(s). 4. Verify that the fuel pressure is sufficient to supply fuel to the combustion chamber. Inspect the connections to the fuel pressure switches. Make sure they are functioning properly. 5. Inspect the Airflow Switch and make sure that it is functioning properly. 6. Check the flame detector sighting position; reset and recycle. Measure the flame signal strength. Verify that it meets specifications. If not, refer to the flame detector and/or flame amplifier checkout procedures in the installation instructions. 7. Replace the flame amplifier and/or the flame detector, if necessary. 8. If the fault persists, replace the relay module.
Code 2-3 *Flame Signal Overrange*	Flame signal value is too high to be valid.	<ol style="list-style-type: none"> 1. Make sure the flame detector and flame amplifier are compatible. 2. Remove the flame amplifier and inspect its connections. Reset the flame amplifier. 3. Reset and sequence the relay module. 4. Check the flame detector sighting position; reset and recycle. Measure flame strength. Verify that it meets specifications. If not, refer to the flame detector and/or flame amplifier checkout procedures in the installation instructions. 5. If the code reappears, replace the flame amplifier and/or the flame detector. 6. If the fault persists, replace the relay module.
Code 3-1 *Running/Interlock Switch Problem*	Running or Lockout Interlock fault during Prepurge.	<ol style="list-style-type: none"> 1. Check wiring; correct any errors. 2. Inspect the fan; make sure there is no air intake blockage and that it is supplying air. 3. Make sure the Lockout Interlock switches are functioning properly and the contacts are free from contaminants. 4. Reset and sequence the relay module to Prepurge (place the TEST/RUN Switch in the TEST position, if available). Measure the voltage between terminal 7 and G (ground); 120 Vac should be present. Switch TEST/RUN back to RUN. 5. If steps 1 through 4 are correct and the fault persists, replace the relay module.

Table 10. Blinking Fault Codes and Recommended Troubleshooting (Continued).

Blink Code	System Failure	Recommended Troubleshooting
Code 3-2 *Running/Interlock On During Standby*	Lockout Interlock powered at improper point in sequence or On in Standby.	<ol style="list-style-type: none"> 1. Check wiring to make sure that the Lockout Interlocks are connected properly between terminals 6 and 7. Correct any errors. 2. Reset and sequence the relay module. 3. If the fault persists, measure the voltage between terminal 6 and G (ground), then between terminal 7 and G. If there is 120 Vac at terminal 6 when the controller is off, the controller switch may be bad or is jumpered. 4. If steps 1 through 3 are correct and there is 120 Vac at terminal 7 when the controller is closed and the fault persists, check for a welded or jumpered Running Interlock or Airflow Switch. Correct any errors. 5. If steps 1 through 4 are correct and the fault persists, replace the relay module.
Code 3-3 *VPS in Improper State*	VPS (Valve Proving Switch) in wrong state during VPS Test.	<ol style="list-style-type: none"> 1. Check wiring, making sure upstream valve is connected to terminal 9 and downstream valve is connected to terminal 17. 2. Conduct Valve Seat leakage test using a manometer. 3. Reset and sequence the relay module; if fault repeats, test VPS (connected to terminal 16) is functioning properly; replace if necessary. 4. Reset and sequence the relay module. 5. If fault persists, replace the relay module.
Code 4-1 *Purge Card Problem*	No purge card or the purge card timing has changed from the original configuration.	<ol style="list-style-type: none"> 1. Make sure the purge card is seated properly. 2. Inspect the purge card and the connector on the relay module for any damage or contaminants. 3. Reset and sequence the relay module. 4. If the fault code reappears, replace the purge card. 5. Reset and sequence the relay module. 6. If the fault code persists, replace the relay module.
Code 4-2 *Wiring Problem/Internal Fault*	Pilot (ignition) valve terminal, main valve, ignition or Main Valve 2 was on when it should be off.	<p>⚠ WARNING Electrical Shock Hazard; Fire or Explosion Hazard. Can cause severe injury, death or property damage. Remove system power and turn off power supply.</p> <ol style="list-style-type: none"> 1. Remove system power and turn off fuel supply. 2. Check wiring; correct any errors. 3. inspect Pilot Fuel Valve(s), both places, and connections. 4. Reset and sequence the relay module. 5. If the fault persists, replace the relay module.
Code 4-3 *Flame Amplifier Problem*	Flame not sensed, or sensed when it should be off.	<ol style="list-style-type: none"> 1. Check wiring; correct any errors. 2. Make sure the flame amplifier and flame detector are compatible. 3. Remove the flame amplifier and inspect the connections. Reseat the amplifier. 4. Reset and sequence the relay module. 5. If the code reappears, replace the flame amplifier and/or the flame detector. 6. If the fault persists, replace the relay module.
Code 4-4 *Configuration Jumper Problem*	The configuration jumpers differ from the sample taken at startup.	<ol style="list-style-type: none"> 1. Inspect the jumper connections. Make sure the clipped jumpers were completely removed. 2. Reset and sequence the relay module. 3. If the fault persists, replace the relay module.
Code 5-1 *Preignition Interlock*	Preignition Interlock fault.	<ol style="list-style-type: none"> 1. Check wiring and correct any errors. 2. Check Preignition Interlock switches to assure proper functioning. 3. Check fuel valve operation. 4. Reset and sequence the relay module; monitor the Preignition Interlock status. 5. If the fault persists, replace the relay module.
Code 5-2 *High Fire Sw. or Low Fire Sw.*	Either High Fire Switch or Low Fire Switch failure.	<ol style="list-style-type: none"> 1. Check wiring and correct any errors. 2. Reset and sequence the relay module. 3. Use manual motor potentiometer to drive the motor open and closed. Verify at motor switch that the end switches are operating properly. Use RUN/TEST switch if manual potentiometer is not available. 4. Reset and sequence the relay module. 5. If the fault persists, replace the relay module.

Table 10. Blinking Fault Codes and Recommended Troubleshooting (Continued).

Blink Code	System Failure	Recommended Troubleshooting
Code 5-3 *Man-Open Sw.; Start Sw. or Control On*	Man-Open Switch, Start Switch or Control On in the wrong operational state.	<ol style="list-style-type: none"> 1. Check wiring and correct any errors. 2. Make sure that the Manual Open Valve Switch, Start Switch and Control are operating properly. 3. Stat Switch held "On" too long. 4. Reset and sequence the relay module. 5. Reset and sequence the relay module. If the fault persists, replace the relay module (RM7838A1014; RM7838B1013 or RM7838C1004 only).
Code 6-1 *Internal Faults*	Relay Module self-test failure.	<ol style="list-style-type: none"> 1. Reset and sequence the relay module. 2. If fault reappears, remove power from the device, reapply power, then reset and sequence the relay module. 3. If the fault persists, replace the relay module.
Code 6-2 *Internal Faults*	Relay Module Self-Test failure.	<ol style="list-style-type: none"> 1. Reset and sequence the relay module. 2. If fault reappears, remove power from the device, reapply power, then reset and sequence the relay module. 3. If fault does not repeat on the next cycle, check for electrical noise being copied into the relay module through the external loads or possibly an electrical grounding issue. 4. If the fault persists, replace the relay module.
Code 6-3 *Device Specific*	Fault with special OEM input circuits.	<ol style="list-style-type: none"> 1. Check wiring and operation of special OEM inputs. 2. Reset and sequence the relay module. 3. If fault reappears, remove power from the device, reapply power, then reset and sequence the relay module. 4. If the fault does not repeat on the next cycle, check for electrical noise being copied into the relay module through the external loads or possibly an electrical grounding issue. 5. If the fault persists, replace the relay module.
Code 6-4 *Accessory Fault*	Unused at this time.	—
Code 7-7 *Unused*	Unused at this time.	—

APPENDIX A

Valve Proving Test

The Valve Proving System feature offers a systematic way of testing the valve seat integrity to assure the valves are in the closed position when the system is off-line, in STANDBY.

The following steps are to determine the test time for the relay module to verify the valve seats are not leaking at a rate of greater than/equal to 0.1% of the burner capacity.

The following diagram shows a typical valve train. The legend identifies information that will be used to fill out the worksheet that appears at the end of this appendix.

WARNING

Explosion Hazard.
Can cause severe injury, death or property damage.

Be sure to select adequate testing times when the Valve Proving feature is selected. A shorter time can result in inadequate leak testing of the valves.

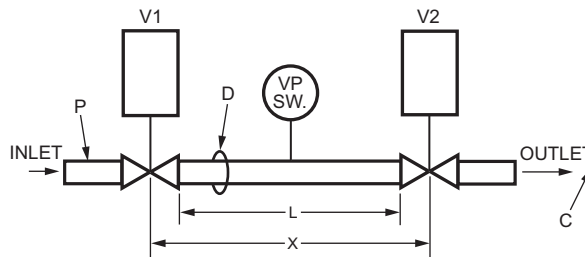

LEGEND

- V1 UPSTREAM VALVE
- V2 DOWNSTREAM VALVE
- D PIPE DIAMETER (IN INCHES.) USED TO DETERMINE A; ARE FOUND IN TABLE III
- L PIPE LENGTH (IN FEET)
- P VALVE INLET PRESSURE (PSIG)
- C BURNER MAX. FIRING (CFH)
- X CALCULATED TEST VALVE TRAIN VOLUME

M22778

Fig. 21. Typical valve train layout.

1. Identify items of your system and fill in the “Information” portion of the worksheet.
2. Go to the Lookup Tables noted (13, 14, or 15) to get the results for your system.

IMPORTANT

The tables show information on Honeywell Valves only. Contact other valve manufacturers to obtain data on their specific valves.

3. Use appropriate Results column items to fill in the Valve Train Volume Formula and the Calculation of Valve Proving Test Time.
4. Round up the time to the nearest second.
5. The test time calculated is the time you will enter into the VPS Setup.

Calculation of Valve Train Volume

$$X = V1 + V2 + (A \times L / 144)$$

Calculation of Valve Proving Test Time

$$\text{Test Time} = 187,000 \times (P \times X) / C$$

Table 11. Valve Proving Test Time Symbols and Descriptions.

Symbol	Unit	Description
X	ft ³	Volume between the two valves to be tested.
V ₁	ft ³	Volume of upstream valve outlet cavity.
V ₂	ft ³	Volume of downstream valve inlet cavity.
L	ft	Length of pipe between valves.
D	npt	Pipe Size—used to define A
A	in. ²	Pipe Cross Section Area (from Table III)
Test Time	Seconds	Minimum VPS test period.
P	psi	Gas inlet pressure to upstream valve.
C	ft ³ /hr	Burner Capacity.

NOTE: V1 is the outlet cavity of the upstream valve and V2 is the inlet cavity of the downstream valve.

NOTE: 10 seconds is the minimum test time allowed. If your calculations are less than 10 seconds, enter 10 seconds.

Example:

We have a 2.5 MBTU burner with 2 psi valve train inlet pressure. The upstream valve is a proof-of-closure V5044 with a solenoid V4295 valve downstream. We have a 2 in. NPT pipe, 1-3/4 ft long, between the valves.

Table 12. VPS Worksheet Example.

Item	Description	Information	Lookup Table	Results	Formula Item
V1	Upstream Valve Volume	V5055	13	0.0218	V1
V2	Downstream Valve Volume	V4295	14	0.0267	V2
D	Pipe Size (in.)	2 in. NPT	15	3.356	A
L	Pipe Length (ft)	1.75 ft	—	1.75	L
P	Valve Inlet Pressure (psig) ^a	2	—	2	P
C	Burner Maximum Firing (cf/hr) ^b	2.5 mbtu	—	2500	C

^a Divide inches w.c. by 2.7 to get psi.

^b Divide Btuh by 1000 to get cf/hr for natural gas or by 2550 to get cf/hr for LP gas.

Calculation of Valve Train Volume:

$$X = V1 + V2 + (A \times L \div 144)$$

$$X = 0.0218 + 0.0267 + (3.356 \times 1.75 \div 144) = 0.0893.$$

$$\text{Test Time} = 187,000 \times (P \times X \div C)$$

$$\text{Test Time} = 187,000 \times (2 \times 0.0893 \div 2500) = 13.4 \text{ seconds.}$$

Calculation of Valve Proving Test Time:

Round up to 14 seconds; enter 14 seconds into the VPS Setup.

Table 13. V1 Upstream Valve Volumes for Honeywell Valves.

Pipe Size NPT (inches)	V4295	V4297A1013	V4297A1005	V48	V5055	V5097A1004	V5097A1012
3/8	0.0002	—	—	—	—	—	—
1/2	0.0002	—	—	—	—	—	—
3/4	0.0008	0.0093	0.0090	0.0010	0.0046	0.0066	—
1	0.0009	0.0093	0.0090	0.0010	0.0046	0.0066	—
1-1/4	0.0045	0.0093	0.0090	0.0035	0.0046	0.0066	—
1-1/2	0.0045	0.0093	—	0.0035	0.0218	0.0066	—
2	0.0089	0.0093	—	0.0048	0.0218	0.0066	0.0285
2-1/2	0.0441	—	—	0.0048	0.0227	—	0.0285
3	0.0441	—	—	0.0048	0.0227	—	0.0285
4	—	—	—	—	0.0779	—	—

Table 14. V2 Downstream Valve Volumes for Honeywell Valves.

Pipe Size NPT (inches)	V4295	V4297A1013	V4297A1005	V48	V5055	V5097A1004	V5097A1012
3/8	0.0011	—	—	—	—	—	—
1/2	0.0011	—	—	—	—	—	—
3/4	0.0026	0.0282	0.0232	0.0048	0.0067	0.0093	—
1	0.0036	0.0282	0.0232	0.0048	0.0067	0.0093	—
1-1/4	0.0148	0.0282	0.0232	0.0110	0.0067	0.0093	—
1-1/2	0.0148	0.0282	—	0.0110	0.0238	0.0093	—
2	0.0267	0.0282	—	0.0184	0.0238	0.0093	0.0303
2-1/2	0.0554	—	—	0.0184	0.0245	—	0.0303
3	0.0554	—	—	0.0184	0.0245	—	0.0303
4	—	—	—	—	0.0801	—	—

Table 15. Schedule 40 Pipe Internal Cross-Sectional Area.

Pipe Size NPT (Inches)	Cross-Sectional Area (Sq. In.) "A"
3/8	0.191
1/2	0.304
3/4	0.533
1	0.864
1-1/4	1.498
1-1/2	2.036
2	3.356
2-1/2	4.788
3	7.393
4	12.730

Table 16. VPS Worksheet.

Item	Description	Information	Lookup Table	Results	Formula Item
V1	Upstream Valve Volumes		13		V1
V2	Downstream Valve Volumes		14		V2
D	Pipe Size (in.)		15		A
L	Pipe Length (ft)		—		L
P	Valve Inlet Pressure (psig) ^a		—		P
C	Burner Maximum Firing (cf/hr) ^b		—		C

^a Divide inches w.c. by 27.7 to get psi.

^b Divide Btuh by 1000 to get cf/hr for natural gas or by 2550 to get cf/hr for LP gas.

SAFETY AND SECURITY

Physical device protection

Device shall be accessible to authorized personnel only – Installation on publicly accessible places is not recommended as this could lead to unwanted and potentially unsafe changes to device (wiring, configuration, etc).

It is recommended to lock the device in an enclosed cabinet with access allowed only to approved and trained personnel. Also, it is strongly advised to keep all the wiring of device physically secure.

Physical protection of the device is applied via Run/Test switch label/seal. It is intended to prevent and detect unauthorized access.

Modbus & DDL Interface security

Any conducts critical to device functionality (DDL, Modbus lines etc.) shall be physically protected (installed outside public access) since they could be damaged or tampered-with by unauthorized people, either accidentally or for purpose.

Modbus RS-485 & DDL protocols do not support security features. For DDL interface - only DDL devices shall be connected to the Burner Controller DDL line.

License agreement

Copying and reverse engineering is prohibited by the law.

For More Information

The Honeywell Thermal Solutions family of products includes Honeywell Combustion Safety, Eclipse, Exothermics, Hauck, Kromschröder and Maxon. To learn more about our products, visit ThermalSolutions.honeywell.com or contact your Honeywell Sales Engineer.

Honeywell Process Solutions

Honeywell Thermal Solutions (HTS)
1250 West Sam Houston Parkway
South Houston, TX 77042
ThermalSolutions.honeywell

® U.S. Registered Trademark
© 2019 Honeywell International Inc.
32-00205-01 M.S. 02-19
Printed in United States

Honeywell