

IB IL AI 4/I/4-20-ECO

**Inline ECO, analog input terminal,
analog inputs: 4, 4 mA ... 20 mA,
connection technology: 2-conductor**

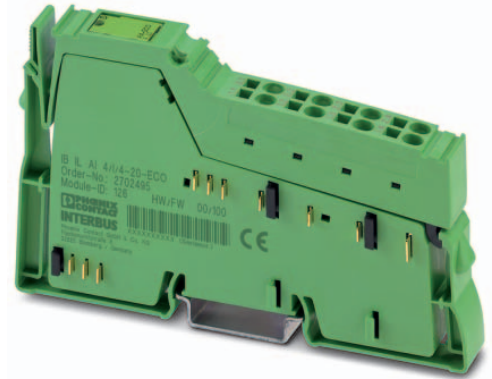

Data sheet
107265_en_00

© PHOENIX CONTACT 2016-10-26

1 Description

The terminal is designed for use within an Inline station.
It is used to acquire analog current signals.

The measured values are depicted in standardized
representation format.

Inline ECO terminals are approved for the temperature
range from 0°C to +55°C. The electronics base and Inline
connector are supplied as standard.

Features

- 4 analog input channels
- Connection of sensors in 2-wire technology
- Current range: 4 mA ... 20 mA
- Data format: standardized representation
- Resolution: 12 bits
- Diagnostic indicator



This data sheet is only valid in association with the IL SYS INST UM E user manual.



Make sure you always use the latest documentation.
It can be downloaded from the product at phoenixcontact.net/products.

2	Table of contents	
1	Description	1
2	Table of contents	2
3	Ordering data	3
4	Technical data	4
5	Additional technical data.....	6
	5.1 Drift response	6
	5.2 Tolerances influenced by electromagnetic interference	6
6	Internal circuit diagram	7
7	Electrical isolation.....	7
8	Terminal point assignment.....	8
9	Connection example.....	8
10	Installation instructions	8
11	Connection notes	8
12	Local diagnostic indicator	8
13	Process data.....	9
14	Representation of measured values	9

3 Ordering data

Description	Type	Order No.	Pcs./Pkt.
Inline ECO, Analog input terminal, Analog inputs: 4, 4 mA ... 20 mA, Connection method: 2-wire, Transmission speed in the local bus 500 kBit/s, Degree of protection IP20, including Inline connector	IB IL AI 4/I/4-20-ECO	2702495	1
Accessories	Type	Order No.	Pcs./Pkt.
Shield connection clamp, for shield on busbars, contact resistance < 1 mΩ (Assembly)	SK 8	3025163	10
Shield connection clamp, for shield on busbars, contact resistance < 1 mΩ (Assembly)	SK 14	3025176	10
Shield connection clamp, for shield on busbars, contact resistance < 1 mΩ (Assembly)	SK 20	3025189	10
Shield connection clamp, for shield on busbars, contact resistance < 1 mΩ (Assembly)	SK 35	3026463	10
Support bracket for busbars (Assembly)	AB-SK	3025341	10
Support bracket, Bracket for busbars, set every 20 cm, Length: 95.5 mm, Width: 6.2 mm, Color: gray (Assembly)	AB-SK 65	3026489	10
Support bracket, Bracket for busbars, set every 20 cm, Length: 10 mm, Width: 56 mm, Height: 20 mm, Color: silver (Assembly)	AB-SK/E	3026476	10
PEN conductor busbar, 3mm x 10 mm, length: 1000 mm (Assembly)	NLS-CU 3/10 SN 1000MM	0402174	10
Connection terminal block, Connection method Screw connection, Cross section: 0.5 mm ² - 6 mm ² , Width: 7 mm, Color: silver	AK 4	0404017	50
Connection terminal block, Connection method Screw connection, Cross section: 0.5 mm ² - 6 mm ² , Width: 7 mm, Color: green-yellow	AKG 4 GNYE	0421029	50
Connection terminal block, Connection method Screw connection, Cross section: 0.5 mm ² - 6 mm ² , Width: 7 mm, Color: black	AKG 4 BK	0421032	50
Connector, for digital 1, 2 or 8-channel Inline terminals (Connector/Adapter)	IB IL SCN-8	2726337	10
Labeling field, width: 12.2 mm (Marking)	IB IL FIELD 2	2727501	10
Documentation	Type	Order No.	Pcs./Pkt.
User manual, English, Automation terminals of the Inline product range	IL SYS INST UM E	-	-
Data sheet, English, INTERBUS addressing	DB GB IBS SYS ADDRESS	-	-

4 Technical data

Dimensions (nominal sizes in mm)

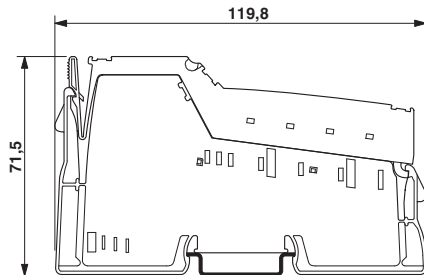

Width	12.2 mm
Height	119.8 mm
Depth	71.5 mm

General data

Color	green
Weight	60 g (with connector)
Ambient temperature (operation)	0 °C ... 55 °C
Ambient temperature (storage/transport)	-25 °C ... 85 °C
Permissible humidity (operation)	10 % ... 95 % (according to DIN EN 61131-2)
Permissible humidity (storage/transport)	10 % ... 95 % (according to DIN EN 61131-2)
Air pressure (operation)	70 kPa ... 106 kPa (up to 3000 m above sea level)
Air pressure (storage/transport)	70 kPa ... 106 kPa (up to 3000 m above sea level)
Degree of protection	IP20
Protection class	III, IEC 61140, EN 61140, VDE 0140-1

Connection data

Designation	Inline connector
Connection method	Spring-cage connection
Conductor cross section solid / stranded	0.08 mm ² ... 1.5 mm ² / 0.08 mm ² ... 1.5 mm ²
Conductor cross section [AWG]	28 ... 16
Stripping length	8 mm

Interface Inline local bus

Number	2
Connection method	Inline data jumper
Transmission speed	500 kBit/s

Inline potentials / Power consumption

Communications power U_L	7.5 V DC (via voltage jumper)
Current consumption from U_L	typ. 60 mA
I/O supply voltage U_{ANA}	24 V DC
Current consumption from U_{ANA}	typ. 15 mA
Power consumption	typ. 0.8 W max. 0.9 W

Analog inputs

Number of inputs	4
Description of the input	Single-ended inputs, current
Connection method	Inline connector
Connection method	2-wire
Note regarding the connection technology	Shielded, twisted pair
Current input signal	4 mA ... 20 mA
Resolution A/D	12 bit
Measured value representation	16 bits
Data formats	Standardized representation
Process data update	< 10 ms
Precision	typ. 0.1 % max. 0.3 %
Input resistance current input	200 Ω
Open circuit response	goes to 0 mA, from < 3.2 mA open circuit indicated in the process data
Overload protection	max. ± 10 V DC, corresponds to max. ± 50 mA through the shunts
Transient protection	Suppressor diode

Programming Data

ID code (hex)	7E
ID code (dec.)	126
Length code (hex)	04
Process data channel	64 Bit
Input address area	8 Byte
Output address area	0 Byte
Parameter channel (PCP)	0 Byte
Register length (bus)	64 Bit

Configuration and parameter data in a PROFIBUS system

Required parameter data	1 Byte
Need for configuration data	4 Byte

Error messages to the higher level control or computer system

Failure of the internal I/O supply	I/O error message sent to the bus coupler
Checksum error	I/O error message sent to the bus coupler

Electrical isolation/isolation of the voltage areas

Test section	Test voltage
Bus logic (local bus, communications power)	500 V AC, 50 Hz, 1 min.
Analog I/O	500 V AC, 50 Hz, 1 min.
Functional earth ground	500 V AC, 50 Hz, 1 min.

Conformance with EMC Directive 2014/30/EU**Noise immunity test in accordance with EN 61000-6-2**

Electrostatic discharge (ESD) EN 61000-4-2/IEC 61000-4-2	Criterion B, 6 kV contact discharge, 8 kV air discharge
Electromagnetic fields EN 61000-4-3/IEC 61000-4-3	Criterion A, Field intensity: 10 V/m
Fast transients (burst) EN 61000-4-4/IEC 61000-4-4	Criterion B, 2 kV
Transient overvoltage (surge) EN 61000-4-5/IEC 61000-4-5	Criterion B, supply lines DC: ± 1 kV/ $\pm 0,5$ kV (symmetrical/asymmetrical), shielded I/O cables: ± 1 kV
Conducted interference EN 61000-4-6/IEC 61000-4-6	Criterion A; Test voltage 10 V

Noise emission test according to EN 61000-6-3

Radio interference properties EN 55022	Class A
--	---------

Approvals

For the latest approvals, please visit phoenixcontact.net/products.

5 Additional technical data**5.1 Drift response**

Measuring range	Drift (maximum)
4 mA ... 20 mA	± 100 ppm/K

5.2 Tolerances influenced by electromagnetic interference

Type of electromagnetic interference		Typical deviation in %
Electromagnetic fields	EN 61000-4-3/IEC 61000-4-3	$< \pm 1.0$ %
Fast transients (burst)	EN 61000-4-4/IEC 61000-4-4	$< \pm 1.0$ %
Conducted interference	EN 61000-4-6/IEC 61000-4-6	$< \pm 1.0$ %

The typical deviation refers to the measuring range final value.

6 Internal circuit diagram

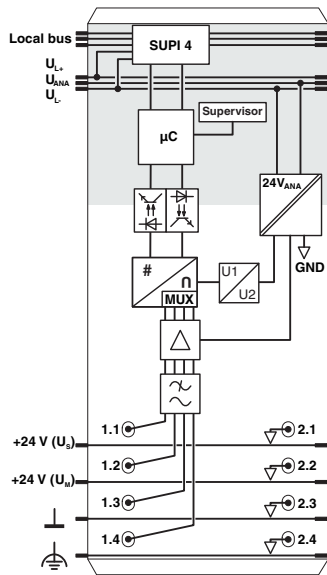



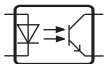







Figure 1 Internal wiring of the terminal points

Key:

	Protocol chip
	Microprocessor
	Hardware monitoring
	Optocoupler
	Power supply unit with electrical isolation
	Power supply unit
	Analog-digital converter with integrated multiplexer
	Input amplifier
	Low pass filter
	Electrically isolated area

7 Electrical isolation

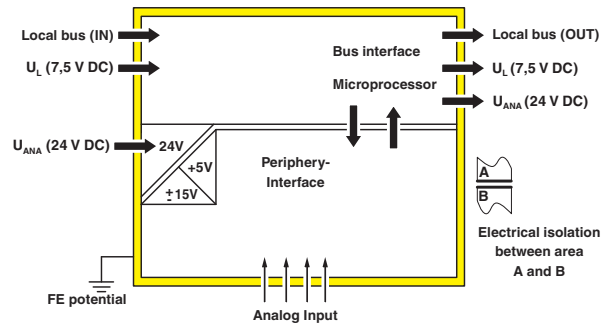

Figure 2 Electrical isolation of the individual function areas

8 Terminal point assignment

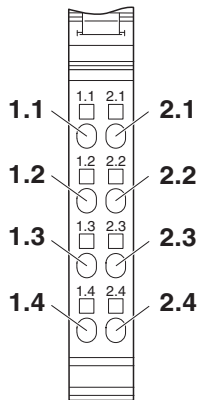

Figure 3 Terminal point assignment

Terminal point	Signal	Terminal point	Signal
1.1	IN01	2.1	GND01
1.2	IN02	2.2	GND02
1.3	IN03	2.3	GND03
1.4	IN04	2.4	GND04

INx (x = 01 ... 04) Current input, channel x
 GND Reference potential



If an input signal is outside the specified range, this can influence the other channels.

9 Connection example

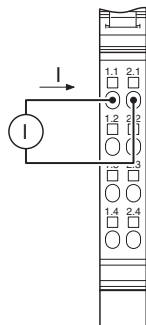

Figure 4 Connecting the sensors

10 Installation instructions

High current flowing through potential jumpers U_M and U_S leads to a temperature rise in the potential jumpers and inside the terminal. To keep the current flowing through the potential jumpers of the analog terminals as low as possible, always place the analog terminals after all the other terminals at the end of the main circuit (for the sequence of the Inline terminals: see also IL SYS INST UM E user manual).

11 Connection notes

Always connect the analog sensors using shielded, twisted pair cables.

Connect the shielding with the shielding accessories given in the ordering data.

12 Local diagnostic indicator



Figure 5 Local diagnostic indicator

Designation	Color	Meaning
D	green	Diagnostics (bus and logic voltage)



For detailed information on diagnostics, please refer to the IL SYS INST UM E user manual.

13 Process data

The terminal uses four words of IN process data.

Each channel is mapped to a word.

The measured values are transmitted to the controller board or the computer using process data input words.

Order of the process data words

Word	0	1	2	3
Signal	IN01	IN02	IN03	IN04
Value	AV01	AV02	AV03	AV04

AV Analog value

The measured values are depicted in standardized representation format.

In this format, data is standardized to the measuring range and represented in such a way that it indicates the corresponding value without conversion.

The measured value is represented in 16 bits.

15	14	13	12	11	10	9	8	7	6	5	4	3	2	1	0
Analog value															

14 Representation of measured values

Input data		4 mA ... 20 mA
hex	dec	mA
8001	Measuring range exceeded (overrange)	> +21.339
43BB	17339	+21.339
3E80	16000	+20.0
2710	10000	+14.0
1770	6000	+10.0
1388	5000	+9.0
03E8	1000	+5.0
0001	1	+4.001
0000	0	+4.0 ... +3.2
8002	Open circuit	< +3.2