

OpenAir® GGD Electronic Damper Actuator

**Designed for UL Listed Fire/Smoke and
Smoke Control Dampers
2-Position, 15-second Runtime
15-second Spring Return Time**



Description

The OpenAir direct-coupled, fast-acting, two-position, spring return electronic actuators are available as 24 Vac, 115 Vac, and 230 Vac models. They are intended for use on UL listed smoke control dampers or combination fire/smoke rated dampers.

Features

- High temperature rated drive system.
- Reversible fail-safe spring return.
- All metal housing.
- Teflon® insulated lead wires.
- Mechanical range adjustment.
- Multiple shaft couplings available; will accommodate up to 1.05-inch shafts.
- Fifteen second nominal open time; 15-second nominal spring return time.
- Fixed dual end switches models available: 5° and 85°

Application

This actuator is used for the control of dampers requiring up to 142 lb-in (16 Nm) driving torque. It is intended for control of UL listed smoke control dampers or combination fire/smoke HVAC dampers. This actuator is designed to meet the 1999 revisions to the UL 555S and AMCA 500-D specifications. Minimum stall torque 350 lb-in.



Product Numbers

Table 1.

Type	Rotation	Shaft Adapter	24 Vac	115 Vac	230 Vac
Standard	95°	Self-centering	GGD121.1U	GGD221.1U	GGD321.1U
Eight pack of standard	95°	Self-centering	GGD121.1U/B	GGD221.1U/B	GGD321.1U/B
With oversize shaft adapter	95°	Oversized	--	GGD221.3U	--
With Auxiliary Switches	95°	Self-centering	GGD126.1U	GGD226.1U	GGD326.1U

Specifications	Operating voltage	24 Vac \pm 20% 115 Vac \pm 15% 230 Vac \pm 10%
	Power supply	
	Frequency	50/60 Hz
	Power consumption	
	running	150 VA @ 60 Hz 160 VA @ 50 Hz
	holding	10 VA (nominal)
Equipment rating	Class 1, in accordance with UL/CSA/NEC	
Function	Running torque (minimum)	142 lb-in (16 Nm)
	Spring return torque (minimum)	108 lb-in (12 Nm)
	Minimum stall torque	350 lb-in (39 Nm)
	Torque reduction at elevated temperature	Less than 10%
	Runtime for 90°	
	operating with motor at 60 Hz	15 seconds nominal
	closing (on power loss) with spring return	15 seconds maximum
	Nominal angle of rotation	90°
	Maximum angle of rotation	95°
Auxiliary Switches (GGDx26.1U)	24 Vac to 250 Vac, 24 Vdc, 6A resistive	2FLA/12 LRA SPST Fixed 5° and 85°
Life Expectancy	Minimum 35,000 full stroke cycles.	
Mounting	Damper shaft size	
	Standard	3/8 to 1 inch (8 to 25.6 mm)
	Oversize	1.05 inch maximum (26.6 mm)
	Minimum shaft length	3/4-inch (20 mm)
Housing	Enclosure	NEMA 1
	Material	Die-cast aluminum alloy
Ambient conditions	Ambient temperature	
	operation	0 to 130°F (-18 to 55°C) One time 350°F (177°C) for 30 minutes (per UL555S)
	storage and transport	-25 to 158°F (-32 to 70°C)
	Ambient humidity (non-condensing)	Maximum 95% rh
Agency certification	UL listed to UL873 cUL certified to Canadian standard C22.2 No. 24-93 Australian EMC Framework (C-tick) with the limits per AS/NZS CISPR 11:2004 (2 nd Edition)	
Miscellaneous	Pre-cabled connection	18 AWG
	Dimensions	See Figure 2.
	Weight	\approx 7 lbs. (3.2 kg)
	Eight pack	\approx 56 lbs. (25.4 kg)

Warning/Caution Notations

WARNING		Personal injury/loss of life may occur if you do not perform a procedure as specified.
CAUTION:		Equipment damage may occur if you do not follow a procedure as specified.

Accessories

E00500RI

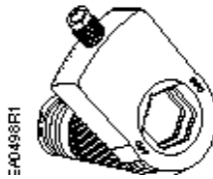
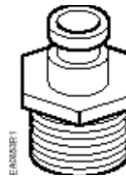
**985-006** Anti-rotation (mounting) bracket.**985-004**
Self-centering shaft
adapter.**ASK74.1** Oversized shaft
adapter will accommodate
up to a 1.05-inch (26.6 mm)
diameter shaft. Use for
coupling to 1-inch
jackshafts that are slightly
oversized.**985-035P25** Conduit
adapter for accom-
modating a conduit
box (pk of 25).**985-008P20** Conduit
adapter for a 1/2-inch
(12 mm) NPT
connector (pk of 20).**Operation**

When power is applied, the actuator coupling moves toward the open position, “90°”. The actuator opens in fifteen seconds nominal, 90° at 60 Hz. In the event of a power failure or when operating voltage is turned off, the actuator returns to the “0” position. The return time is fifteen seconds maximum for 90°.

The GGD actuator does not require any periodic cycling to function properly as an integral part of an active smoke control damper system.

NOTE: **Siemens Industry, Inc. however, strongly suggests that all life safety systems are functionally checked periodically.** Check the smoke control damper/actuator every time you functionally check your smoke detectors, emergency lights, and/or power generators for operation.

Installation

Refer to the installation instructions for detailed guidelines.



CAUTION:

Read and carefully follow the *OpenAir® GGD Electronic Damper Actuator Designed for UL Listed Fire/Smoke and Smoke Control Dampers Installation Instructions (129-255)* to avoid equipment damage.

Wiring

All wiring must conform to NEC and local codes and regulations.

Wire Designations

24 Vac

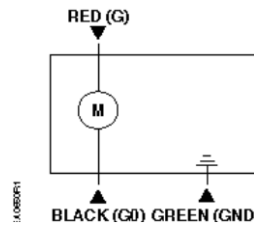

Function	Color
Supply (SP)	Red
Neutral (SN)	Black
Ground	Green

115 Vac

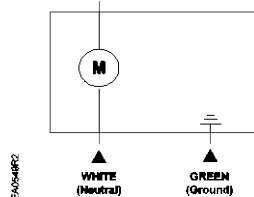

Function	Color
Line	Black
Neutral	White
Ground	Green

230 Vac

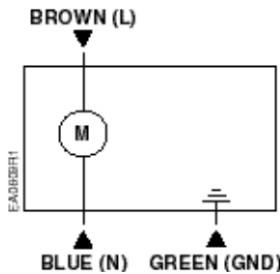

Function	Color
Line	Brown
Neutral	Blue
Ground	Green



CAUTION:

The actuator must be wired with a 230 Vac line with respect to neutral and the ground lead must be connected for proper protection of the actuator. Any other connection, such as phase to phase, can damage the actuator.

Auxiliary Switches

Switch	Wire Color	Switch Makes	Switch Brakes
5°	Gray	< 5°	> 5°
85°	Yellow	> 85°	< 85°

Figure 1. Dual Fixed End Switches.

Both sets of contacts are open when actuator is between 5° and 85°.

Service



WARNING:

Do not open the actuator. Personal injury may occur if opened. Opening the actuator voids the warranty.

If the actuator is inoperative, replace the unit.

Dimensions

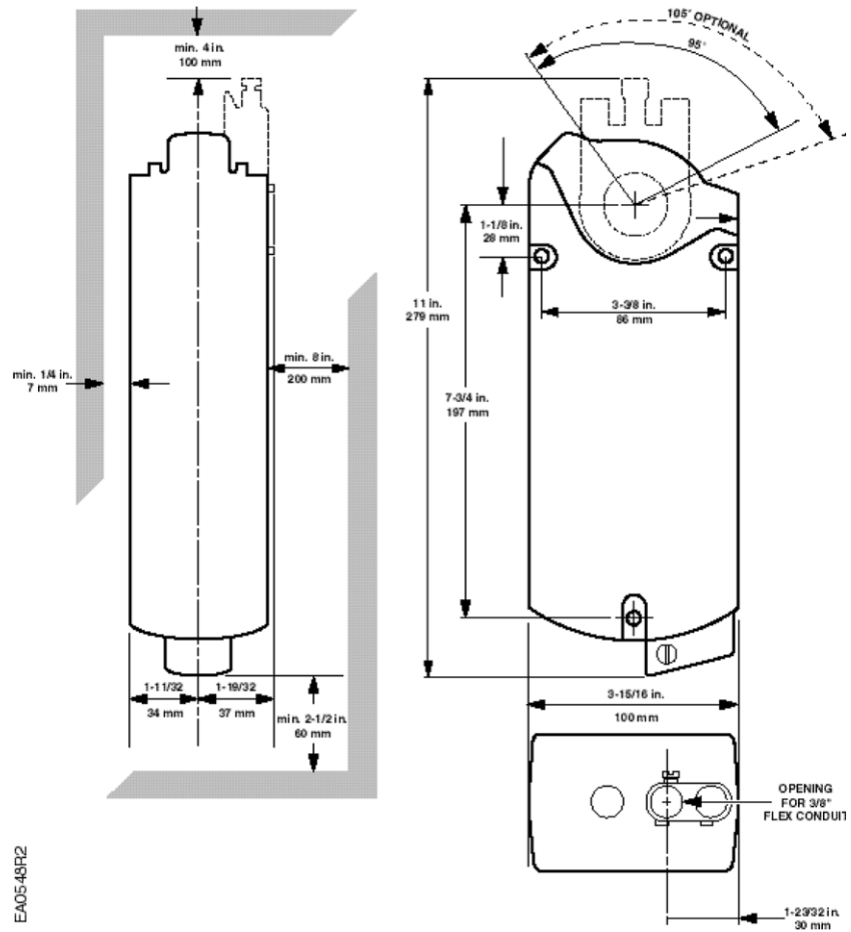

Figure 2. Dimensions of the Actuator.

Information in this publication is based on current specifications. The company reserves the right to make changes in specifications and models as design improvements are introduced. OpenAir is a registered trademark of Siemens SCHWEIZ AG. Teflon is a registered trademark of DuPont. Product or company names mentioned herein may be the trademarks of their respective owners. © 2015 Siemens Industry, Inc.